

# marantz®

## Model DV4610 User Guide

---

DVD Player



**ENGLISH**

**WARRANTY**

For warranty information, contact your local Marantz distributor.

**RETAIN YOUR PURCHASE RECEIPT**

Your purchase receipt is your permanent record of a valuable purchase. It should be kept in a safe place to be referred to as necessary for insurance purposes or when corresponding with Marantz.

**IMPORTANT**

When seeking warranty service, it is the responsibility of the consumer to establish proof and date of purchase. Your purchase receipt or invoice is adequate for such proof.

**FOR U.K. ONLY**

This undertaking is in addition to a consumer's statutory rights and does not affect those rights in any way.

**FRANÇAIS**

**GARANTIE**

Pour des informations sur la garantie, contacter le distributeur local Marantz.

**CONSERVER L'ATTESTATION D'ACHAT**

L'attestation d'achat est la preuve permanente d'un achat de valeur. La conserver en lieu sûr pour s'y reporter aux fins d'obtention d'une couverture d'assurance ou dans le cadre de correspondances avec Marantz.

**IMPORTANT**

Pour l'obtention d'un service couvert par la garantie, il incombe au client d'établir la preuve de l'achat et d'en corroborer la date. Le reçu ou la facture constituent des preuves suffisantes.

**DEUTSCH**

**GARANTIE**

Bei Garantiefragen wenden Sie sich bitte an Ihren Marantz-Händler.

**HEBEN SIE IHRE QUITTING GUT AUF**

Die Quittung dient Ihnen als bleibende Unterlage für Ihren wertvollen Einkauf. Das Aufbewahren der Quittung ist wichtig, da die darin enthaltenen Angaben für Versicherungswecke oder bei Korrespondenz mit Marantz angeführt werden müssen.

**WICHTIG!**

Bei Garantiefragen muß der Kunde eine Kaufunterlage mit Kaufdatum vorlegen. Ihren Quittung oder Rechnung ist als Unterlage ausreichend.

**NEDERLANDS**

**GARANTIE**

Voor inlichtingen omtrent garantie dient u zich tot uw plaatselijke Marantz.

**UW KWITANTIE, KASSABON E.D. BEWAREN**

Uw kwitantie, kassabon e.d. vormen uw bewijs van aankoop van een waardevol artikel en dienen op een veilige plaats bewaard te worden voor evt. verwijzing bijv. in verband met verzekering of bij correspondentie met Marantz.

**BELANGRIJK**

Bij een evt. beroep op de garantie is het de verantwoordelijkheid van de consument een gedateerd bewijs van aankoop te tonen. Uw kassabon of factuur zijn voldoende bewijs.

**ESPAÑOL**

**GARANTIA**

Para obtener información acerca de la garantía póngase en contacto con su distribuidor Marantz.

**GUARDE SU RECIBO DE COMPRA**

Su recibo de compra es su prueba permanente de haber adquirido un aparato de valor. Este recibo deberá guardarlo en un lugar seguro y utilizarlo como referencia cuando tenga que hacer uso del seguro o se ponga en contacto con Marantz.

**IMPORTANTE**

Cuando solicite el servicio otorgado por la garantía el usuario tiene la responsabilidad de demostrar cuándo efectuó la compra. En este caso, su recibo de compra será la prueba apropiada.

**ITALIANO**

**GARANZIA**

L'apparecchio è coperto da una garanzia di buon funzionamento della durata di un anno, o del periodo previsto dalla legge, a partire dalla data di acquisto comprovata da un documento attestante il nominativo del Rivenditore e la data di vendita. La garanzia sarà prestata con la sostituzione o la riparazione gratuita delle parti difettose.

Non sono coperti da garanzia difetti derivanti da uso improprio, errata installazione, manutenzione effettuata da personale non autorizzato o, comunque, da circostanze che non possano riferirsi a difetti di funzionamento dell'apparecchio. Sono inoltre esclusi dalla garanzia gli interventi inerenti l'installazione e l'allacciamento agli impianti di alimentazione.

Gli apparecchi verranno riparati presso i nostri Centri di Assistenza Autorizzati.

Le spese ed i rischi di trasporto sono a carico del cliente.

La casa costruttrice declina ogni responsabilità per danni diretti o indiretti provocati dalla inosservanza delle prescrizioni di installazione, uso e manutenzione dettate nel presente manuale o per guasti dovuti ad uso continuato a fini professionali.

**SVENSKA**

**GARANTI**

För information om garantin, kontakta Marantz lokalagent.

**SPAR KVITTOT**

Kvittot är ett inköpsbevis på en värdefull vara. Det skall förvaras säkert och hänvisas till vid försäkringsfall eller vidkorrespondens med Marantz.

**VIKTIGT**

Fö att garantin skall gälla är det kundens sak att framställa bevis och datum om köpet. Kvitto eller faktura är tillräckligt bevis fö detta.

**CE MARKING**

- CE English**  
The DV4610 is in conformity with the EMC directive and low-voltage directive.
- CE Français**  
Le DV4610 est conforme à la directive EMC et à la directive sur les basses tensions.
- CE Deutsch**  
Das Modell DV4610 entspricht den EMC-Richtlinien und den Richtlinien für Niederspannungsgeräte.
- CE Nederlands**  
De DV4610 voldoet aan de EMC eisen en de vereisten voor laag-voltage.

- CE Español**  
El DV4610 está de acuerdo con las normas EMC y las relacionadas con baja tensión.
- CE Italiano**  
Il DV4610 è conforme alle direttive CEE ed a quelle per i bassi voltaggi.
- CE Svenska**  
DV4610 är tillverkad i enlighet med EMC direktiven och direktiven för lågvoltsutrustning.

## English

### WARNINGS

- Do not expose the equipment to rain or moisture.
- Do not remove the cover from the equipment.
- Do not insert anything into the equipment through the ventilation holes.
- Do not handle the mains lead with wet hands.
- Do not cover the ventilation with any items such as tablecloths, newspapers, curtains, etc.
- No naked flame sources, such as lighted candles, should be placed on the equipment.
- When disposing of used batteries, please comply with governmental regulations or environmental public instruction's rules that apply in your country or area.
- Do not place anything about 1 meter above the top panel.
- Make a space of about 0.2 meter around the unit.
- Never spill liquid of any kind on this unit. If liquid is spilled into the unit, consult qualified service engineer.
- No objects filled with liquids, such as vases, shall be placed on the equipment.
- When the switch is in the OFF position, the equipment is not completely switched-off from MAINS.

## Français

### AVERTISSEMENTS

- Ne pas exposer l'appareil à la pluie ni à l'humidité.
- Ne pas essayer de retirer le boîtier de l'appareil.
- Ne rien insérer dans l'appareil par les orifices de ventilation.
- Ne pas manipuler le cordon d'alimentation avec les mains mouillées.
- Ne pas recouvrir les ouïes de ventilation avec un objet quelconque comme une nappe, un journal, un rideau, etc.
- Ne placer aucune source de flamme nue, comme une bougie allumée, sur l'appareil.
- Pour mettre au rebut les piles usées, respecter les lois gouvernementales ou les règlements officiels concernant l'environnement qui s'appliquent à votre pays ou région.
- Ne placer aucun objet à moins d'un mètre environ du panneau supérieur.
- Veiller à ce qu'aucun objet ne soit à moins de 0,2 mètre des côtés de l'appareil.
- Ne renverser aucun liquide sur cet appareil. Si du liquide se répand dans l'appareil, consulter un ingénieur de service qualifié.
- Ne placer aucun objet rempli de liquide, tel que la vase, sur l'appareil.
- Quand même que la touche d'alimentation est mis hors service, l'appareil n'est pas mis hors circuit complètement.

## Deutsch

### WARNHINWEISE

- Das Gerät nicht Regen oder Feuchtigkeit aussetzen.
- Die Abdeckung nicht vom Gerät abnehmen.
- Keine Gegenstände durch die Belüftungsschlitze stecken.
- Das Netzkabel nicht mit feuchten oder nassen Händen anfassen.
- Decken Sie die Lüftungsöffnungen nicht mit einem Tischtuch, einer Zeitung, einem Vorhang usw. ab.
- Es dürfen keine Gegenstände mit offener Flamme, wie etwa brennende Kerzen, auf dem Gerät aufgestellt werden.
- Beachten Sie bei der Entsorgung der verbrauchten Batterien alle geltenden lokalen und überregionalen Regelungen.
- Darauf achten, daß über dem Gerät ein Freiraum von mindestens 1 meter vorhanden ist.
- Auf allen Geräteseiten muß ein Zwischenraum von ungefähr 0,2 meter vorhanden sein.
- Niemals irgendwelche Flüssigkeiten auf dem Gerät verschütten. Falls dennoch Flüssigkeit in das Gerät eindringen sollte, suchen Sie bitte einen qualifizierten Kundendiensttechniker auf.
- Es soll kein mit Wasser gefülltes Gefäß, wie z.B. eine Vase, auf das Gerät gestellt werden.
- Wenn der Schalter sich der AUS-Stellung befindet, ist das Gerät nicht völlig vom Stromnetz getrennt.

## Nederlands

### WAARSCHUWINGEN

- Stel het apparaat niet bloot aan regen of vocht.
- Verwijder de afdekplaat van het apparaat niet.
- Duw niets door de ventilatieopeningen in het apparaat.
- Raak het netsnoer niet met natte handen aan.
- Bedek de ventilatieopeningen niet met enige voorwerpen, zoals tafelkleden, kranten, gordijnen, enz.
- Plaats geen brandende voorwerpen, zoals kaarsen, op het apparaat.
- Volg bij het weggooien van verbruikte batterijen de overheidswetgeving of milieuvoorschriften op die van kracht zijn in het land of de regio waarin u zich bevindt.

- Zorg dat er tenminste 1 meter vrije ruimte boven het toestel is.
- Zorg dat er 0,2 meter vrije ruimte rond het toestel is.
- Mors nooit vloeistoffen over dit apparaat. Laat het apparaat nakijken door een gekwalificeerd servicemonteur wanneer er vloeistof in het apparaat is gemorst.
- Plaats geen met vloeistof gevulde voorwerpen zoals vazen op het apparaat.
- Wanneer de schakelaar in de stand uit staat, is de NETVOEDING naar het apparaat niet volledig uitgeschakeld.

## Español

### ADVERTENCIAS

- No exponga el equipo a la lluvia ni a la humedad.
- No extraiga la tapa del equipo.
- No introduzca nada en el interior del equipo a través de los orificios de ventilación.
- No maneje el cable de alimentación con las manos mojadas.
- No cubra la ventilación con objetos como manteles, periódicos, cortinas, etc.
- No deben colocarse sobre el equipo elementos con fuego, por ejemplo velas encendidas.
- Cuando se eliminen baterías usadas, deben cumplirse las reglamentaciones oficiales o las normas de protección medioambiental aplicables en su país o en su zona.
- No ponga nada a menos de 1 metro por encima del panel superior
- Deje un espacio de unos 0,2 metro alrededor de la unidad.
- No derrame nunca líquidos de ninguna clase en este aparato. Si se derrama algún líquido en el interior del aparato, consulte a un ingeniero de servicio cualificado.
- No ponga objetos llenados de líquido como floreros en este aparato.
- Aun cuando el botón de alimentación está en la posición apagada, no se apague la alimentación principal completamente en el aparato.

## Italiano

### AVVERTENZE

- Non esporre l'apparecchio alla pioggia o all'umidità.
- Non rimuovere il coperchio dell'apparecchio.
- Non introdurre oggetti all'interno dell'apparecchio attraverso i fori di ventilazione.
- Non toccare il cavo di alimentazione con le mani bagnate.
- Non coprire le fessure di ventilazione con tovaglie, giornali, tende od oggetti analoghi.
- Non posare sull'apparecchio sorgenti di fiamme scoperte quali candele accese.
- Smaltire le pile usate in conformità alle norme governative o disposizioni ambientali vigenti nel proprio paese o zona.
- Non posare nulla per circa un metro sopra il pannello superiore.
- Lasciare 0,2 metro liberi tutto intorno l'unità.
- Non spruzzare mai liquidi di qualsiasi tipo su quest'unità. In caso di penetrazione di liquido nell'unità, rivolgersi ad un tecnico qualificato.
- Non posizionare oggetti contenenti liquidi, come ad esempio vasi, sull'apparecchiatura.
- Quando l'interruttore si trova nella posizione off, l'apparecchiatura non è completamente scollegata dalla RETE.

## Svenska

### VARNINGAR

- Utsätt inte utrustningen för regn eller fukt.
- Ta inte bort utrustningens hölje.
- För inte in föremål i utrustningen genom ventilationshålen.
- Hantera inte nätsladden med våta händer.
- Täck inte för ventilationsöppningarna med några föremål som till exempel bordsdukar, dagstidningar, gardiner e.d.
- Inga föremål med öppen låga, som till exempel tända stearinljus, bör placeras på utrustningen.
- Följ de lagar och miljöskyddsråd som gäller i det land eller område där du bor när du gör dig av med batterier.
- Placera inte någonting närmare än 1 meter ovanför apparaten eller enheten.
- Se till att det finns omkring 0,2 meter fri plats runt omkring enheten.
- Spill aldrig vätskor på DVD-spelaren. Om du skulle spilla vätska inuti den, måste du vända dig till en kvalificerad servicetekniker.
- Ställ inte föremål med vätskor, t.ex. vaser, ovanpå apparaten.
- Även om omkopplaren ställs i avstängt läge (off) är strömförsörjningen till apparaten inte helt bruten utan den är fortfarande ansluten till nätet.

CAUTION : USE OF CONTROLS OR ADJUSTMENTS OR PERFORMANCE OF PROCEDURES OTHER THAN THOSE SPECIFIED HEREIN MAY RESULT IN HAZARDOUS RADIATION EXPOSURE.

## WARNINGS FOR LASER RADIATION

CAUTION : INVISIBLE LASER RADIATION WHEN OPEN. DO NOT STARE INTO BEAM.

DANGER : INVISIBLE LASER RADIATION WHEN OPEN. AVOID DIRECT EXPOSURE TO BEAM.

### A NOTE ABOUT RECYCLING:

This product's packaging materials are recyclable and can be reused. This product and the accessories packed together are the applicable product to the WEEE directive except batteries. Please dispose of any materials in accordance with your local recycling regulations. When discarding the unit, comply with your local rules or regulations. Batteries should never be thrown away or incinerated but disposed of in accordance with your local regulations concerning chemical wastes.

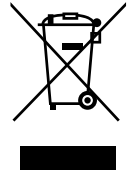

### Make your contribution to the environment!!!

- Used up batteries do not belong in the dust bin.
- You can dispose of them at a collection point for used up batteries or special waste. Contact your council for details.

## TABLE OF CONTENTS

■ <b>PRECAUTIONS</b> .....	2	Title / Chapter Search .....	17
WARNINGS FOR LASER RADIATION .....	4	BY USING THE SEARCH MODE BUTTON .....	17
■ <b>INTRODUCTION</b> .....	5	BY USING THE SKIP BUTTONS ◀◀ ▶▶ .....	17
About Copyright .....	5	Track Search .....	17
Notice for the Progressive Scan Outputs .....	5	BY USING THE SEARCH MODE BUTTON .....	17
Supplied Accessories .....	5	BY USING THE SKIP BUTTONS ◀◀ ▶▶ .....	17
Symbols Used in this Manual .....	5	Time Search .....	17
■ <b>ABOUT THE DISCS</b> .....	6	Repeat .....	18
Playable Discs .....	6	REPEAT TITLE / CHAPTER .....	18
■ <b>FEATURES</b> .....	7	REPEAT TRACK / GROUP / ALL .....	18
■ <b>FUNCTIONAL OVERVIEW</b> .....	8	A-B REPEAT .....	18
FRONT PANEL .....	8	Programme Playback (CD) .....	18
REMOTE CONTROL .....	8	Random Playback (CD) .....	19
Tour of the Remote Control .....	9	MP3 / JPEG / WMA Playback .....	19
Panel Display .....	11	DivX® Playback .....	20
Displays during Operation .....	11	Slide Show Mode .....	21
Using the Remote Control .....	11	On-Screen Information .....	21
Loading the Batteries .....	11	Programme Playback (MP3 / JPEG / WMA) .....	22
■ <b>CONNECTIONS</b> .....	12	Random Playback (MP3 / JPEG / WMA) .....	22
Description - Rear Panel .....	12	Audio Language .....	22
Connection to an Audio System .....	13	Subtitle Language .....	23
Connection to a TV (for Video) .....	14	Stereo Sound Mode .....	23
■ <b>PLAYING A DISC</b> .....	15	Camera Angle .....	23
Basic Playback .....	15	Marker Setup Screen .....	23
CANCELLING AND CALLING BACK .....	15	Virtual Surround .....	24
THE PBC FUNCTION .....	15	■ <b>DVD SETUP</b> .....	24
General Features .....	15	Language Setting .....	24
FL OFF Mode .....	15	Display Setting .....	24
Disc Menus .....	15	Audio Setting .....	25
Title Menu .....	15	Parental Control .....	25
CALLING UP A MENU SCREEN DURING .....	15	PARENTAL LEVEL .....	25
PLAYBACK .....	15	IF YOU FORGET THE PASSWORD .....	26
Still / Pause .....	15	CONTROL LEVELS .....	26
Step by Step Playback .....	16	Others Setting .....	26
Resume .....	16	Reset to the Default Settings (except for .....	26
Playing the Disc Recorded in VR Mode .....	16	PARENTAL and VIDEO OUT) .....	26
(Video Recording Format) .....	16	Language Code List .....	27
Fast Forward / Reverse Search .....	16	■ <b>MAINTENANCE</b> .....	27
Slow Forward / Slow Reverse .....	16	■ <b>TROUBLESHOOTING GUIDE</b> .....	28
Zoom .....	16	■ <b>SPECIFICATIONS</b> .....	29
		■ <b>PIN CONNECTION (A/V EURO CONNECTOR)</b> .....	29

## INTRODUCTION

The serial number of this product may be found on the back of the DVD player. No others have the same serial number as yours. You should record the number and other vital information here and retain this book as a permanent record of your purchase to aid identification in case of theft. Serial numbers are not kept on file.

Date of Purchase	
Dealer Purchase from	
Dealer Address	
Dealer Phone No.	
Model No.	
Serial No.	

### About Copyright

Unauthorized copying, broadcasting, public performance and lending of discs are prohibited. This product incorporates copyright protection technology that is protected by U.S. patents and other intellectual property rights. Use of this copyright protection technology must be authorised by Macrovision, and is intended for home and other limited viewing uses only unless otherwise authorised by Macrovision. Reverse engineering or disassembly is prohibited.



Apparatus Claims of U. S. Patent Nos, 4,631,603, 4,577,216, 4,819,098, and 4,907,093 licensed for limited viewing uses only.

### Notice for the Progressive Scan Outputs

Consumers should note that not all high definition television sets are fully compatible with this product and may cause artifacts to be displayed in the picture. In case of picture problems with 525 or 625 progressive scan output, it is recommended that the user switch the connection to the 'standard definition' output. If there are questions regarding your TV set compatibility with this 525p or 625p DVD player, please contact our customer service centre.

### Supplied Accessories

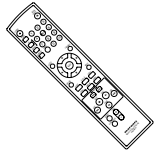
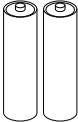
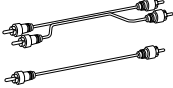
Please check to make sure the following items are included with the main unit in the carton.

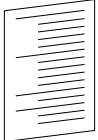
Remote control..... 1 	"AA" (R6P) batteries ..... 2 	Audio (Red and White) cable..... 1 Video (Yellow) cable..... 1 	Remote control bus cable (Orange) ..... 1 	User Guide ..... 1 	Product registration card ..... 1 
--------------------------------------------------------------------------------------------------------------	---------------------------------------------------------------------------------------------------------------------	----------------------------------------------------------------------------------------------------------------------------------------------------------	----------------------------------------------------------------------------------------------------------------------------------	------------------------------------------------------------------------------------------------------------	----------------------------------------------------------------------------------------------------------------------------

### Symbols Used in this Manual

The following symbols appear below in some headings and notes in this manual, with the following meanings.

<b>DVD-V</b> :	Description refers to playback of DVD-Video discs.	<b>JPEG</b> :	Description refers to viewing of JPEG discs.
<b>VCD</b> :	Description refers to playback of Video CDs.	<b>WMA</b> :	Description refers to playback of discs formatted with WMA.
<b>CD</b> :	Description refers to playback of Audio CDs.	<b>DivX®</b> :	Description refers to playback of discs formatted with DivX®.
<b>MP3</b> :	Description refers to playback of discs formatted with MP3.	<b>DVD-RW</b> :	Description refers to playback of the VR mode (Video Recording format).

 is a trademark of DVD Format/Logo Licensing Corporation.

 is trademark of Eastman Kodak Company.

 This label indicates playback compatibility with DVD-RW discs recorded in VR mode (Video Recording format).

 Plays Windows Media™  
Windows Media and the Windows logo are trademarks or registered trademarks of Microsoft Corporation in the United States and/or other countries.

 DivX, DivX Certified, and associated logos are trademarks of DivX, Inc. and are used under license.

Playable Discs

Playable discs	Mark (logo)	Region code	Recorded signals	Disc size	Disc types
DVD-Video * 1, 2, 3, 5					
DVD-RW DVD-R * 1, 3, 4, 5, 6, 7, 8			Digital video (MPEG2) DivX®	12 cm or 8 cm	
Video CD * 1, 3, 5, 9		—	Sound and Pictures		
Audio CD * 4, 5		—	Digital audio	12 cm or 8 cm	
CD-RW CD-R * 4, 5, 7, 8, 9		—	Digital audio MP3 WMA*10 Digital picture (JPEG) DivX®		
Picture CD		—	JPEG	12 cm	

**If you cannot play back a disc which bears one of the marks above, check the following notes.**

- \*1: This player conforms to the PAL colour system. Also you can play discs recorded with the NTSC system via a PAL system TV set.
- \*2: Certain DVD-Video discs do not operate as described in this manual due to the intentions of the disc's producers.
- \*3: Scratched or stained discs may not be played back.
- \*4: Some discs cannot be played back because of incompatible recording conditions, characteristics of the recorder or special properties of discs.
- \*5: You can play back discs which bear the marks above. If you use nonstandardized discs, this unit may not play them back. Even if they are played back, the sound or video quality will be compromised.
- \*6: Only the discs recorded in the video format or Video Recording format, and finalized can be played back. Unfinalized discs cannot be played back. Depending on the recording status of a disc, the disc may not be played back at all or normally (the picture or sound may be distorted, etc.).
- \*7: If there is too much recordable space left on a disc (the used portion is less than 55mm across), it may not play back properly.
- \*8: Do not glue paper or put stickers on to the disc. These may damage the disc, and the unit may not read it correctly.
- \*9: This unit conforms to ver.1.1 and ver.2.0 of Video CD standard with PBC function.  
*Ver. 1.1 (without PBC function):* You can enjoy playback picture as well as music CD.  
*Ver.2.0 (with PBC function):* While using a Video CD with PBC function, "Pbc" appears on the screen and the display.  
**NOTE:** When playing Video CDs with PBC function, some operations (e.g., track search and repeat tracks) cannot be performed. Cancel PBC function temporarily to perform those operations (refer to page 15).

**What is PBC?** "PBC" stands for Playback Control.  
You can play interactive software using menu screens. Refer to instructions in the Video CD.

- \*10: This player cannot play the disc contents protected by Windows Media Digital Rights Management (DRM).
- NOTE:** This player cannot play the DVD-RW discs that supports CPRM (Content Protection for Recordable Media).  
This player cannot play the DVD-R discs recorded in VR mode (Video Recording format).

- **NEVER play back the following discs. Otherwise, malfunction may result!**  
DVD-RAM / CD-I / Photo CD / DVD with region codes other than 2 or ALL / DVD-ROM for personal computers / CD-ROM for personal computers
- **On the following disc, the sound MAY NOT be heard.**  
Super Audio CD
- NOTES:**
  - Only the sound recorded on the normal CD layer can be delivered.
  - The sound recorded on the high density Super Audio CD layer cannot be delivered.
- Any other discs without compatibility indications

**CAUTION:**

- Use caution not to pinch your finger in the disc slot.
- Be sure to remove a disc and unplug the AC power cord from the outlet before carrying the DVD player.

- **Progressive Scan system**  
Unlike conventional interlace scanning, the progressive scan system provides less flickering and images in higher resolution than that of traditional 625i (576i) television signals.
- **Dolby Digital Sound**  
By hooking this player up to a Multi-Channel Dolby Digital decoder, you can enjoy high-quality Dolby Digital 5.1 channel surround sound as heard in the movie theatres.
- **DTS (Digital Theater System)**  
When this player is connected to the DTS decoder, you can enjoy 5.1 channel surround system which reproduces the original sound as truthfully as possible. 5.1 channel surround system is developed by the Digital Theater System, Inc.
- **Still/Fast/Slow/Step Playback**  
Various playback modes are available including still pictures, fast forward/reverse, slow motion and step frames.
- **Random Playback for Audio CD, MP3, JPEG, and WMA**  
This player can shuffle the order of tracks to play them in random order.
- **Programme Playback for Audio CD, MP3, JPEG, and WMA**  
You can programme the order of tracks to play them in any desired order.
- **DVD menus in a desired language**  
You can display DVD menus in a desired language if the language is available on the DVD.
- **Auto Power Off**  
The power turns off automatically if there is no activity at the player or its remote control for more than 30 minutes. (Refer to page 26.)
- **Subtitles in a desired language**  
You can select a desired language for subtitles if the language is available on the disc.
- **Selecting a camera angle**  
You can select a desired camera angle if a disc contains sequences recorded from different angles.
- **Choices for audio language and sound mode**  
You can select a desired audio language and sound mode if different languages and modes are available on the disc.
- **Parental Lock**  
You can set the control level to limit playback of discs which may not be suitable for children.
- **Automatic detection of discs**  
This player automatically detects if a loaded disc is DVD-Video, Video CD, Audio CD, MP3, JPEG, WMA, or DivX®.
- **Playing an MP3 disc**  
You can enjoy MP3 files which are recorded on CD-R/RW.
- **Direct Search**  
You can search a desired title, chapter, and track with the numeric buttons during playback or in stop mode.
- **On-screen display**  
Information about the current operation can be displayed on the TV screen, allowing you to confirm the currently active functions (such as programme playback).
- **FL OFF Mode**  
You can turn off the panel display.
- **Search**  
Chapter search: Search for a desired chapter.  
Title search: Search for a desired title.  
Group search: Search for a desired group.  
Page search: Search for a desired page.  
Track search: Search for a desired track.  
Time search: Search for a desired time point of a title or track.
- **Repeat**  
Chapter: Repeated playback of a chapter of the disc.  
Title: Repeated playback of a title of the disc.  
Track: Repeated playback of a track of the disc.  
All: Repeated playback of the entire disc. (exclude DVD-Video)  
A-B: Repeated playback of a part between two points.  
Group: Repeated playback of a folder of the MP3/JPEG/WMA/DivX® disc.
- **Zoom**  
2-time or 4-time magnified screen can be displayed.
- **Marker**  
The part designated by user can be called back.
- **Resume Play**  
You can resume playback from the point at which the play has been stopped even if the power is turned off.
- **Component Video Out Jacks**  
Jacks located on the back of the DVD player which are used to send high-quality video to a TV via Component Video In Jacks.
- **Bit rate indication**
- **DRC (Dynamic Range Control)**  
You can compress the range of sound volume.
- **MPEG sound**  
This player can handle a disc that supports MPEG audio when it is connected to an MPEG decoder.
- **Displaying JPEG files**  
Kodak Picture CDs can be played. Still images stored in JPEG format on CD-R/RW can also be played.
- **Reproducing WMA files**  
You can enjoy WMA files which are recorded on CD-R/RW.
- **Reproducing DivX® files**  
You can enjoy DivX® files which are recorded on DVD-R/RW or CD-R/RW.
  - Official DivX Certified™ product
  - Plays DivX®5, DivX®4, DivX®3, and DivX® VOD video content (in compliance with DivX Certified™ technical requirements).
  - This player supports Quarter Pixel.
  - This player does not support GMC.

Manufactured under license from Dolby Laboratories. "Dolby" and the double-D symbol are trademarks of Dolby Laboratories.

"DTS" and "DTS Digital Out" are trademarks of Digital Theater Systems, Inc.

"WMA" (Windows Media Audio) is a new audio codec developed by Microsoft® in the United States of America.

## FUNCTIONAL OVERVIEW

### FRONT PANEL

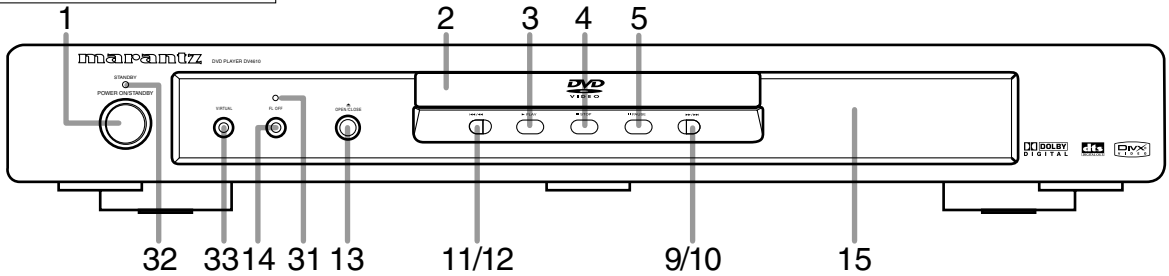

### REMOTE CONTROL

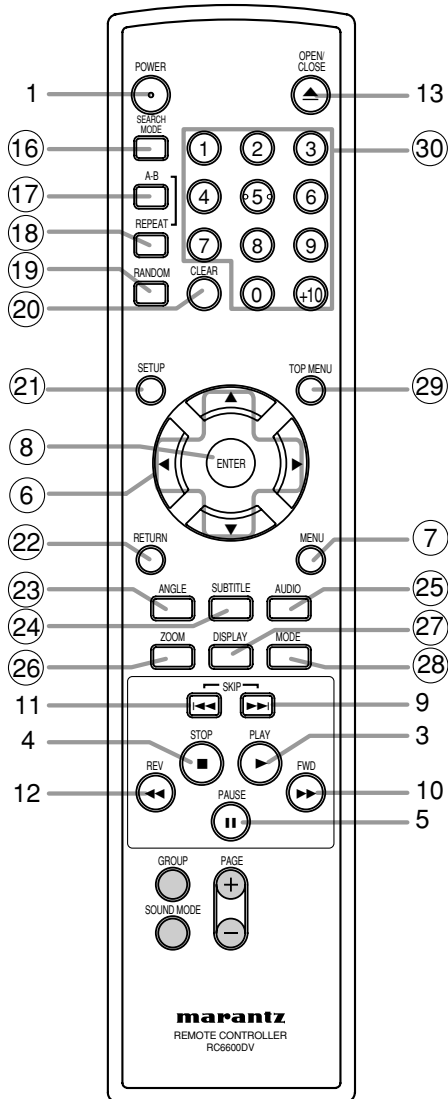

#### NOTES:









- The buttons in gray (○) do not function on this player.
- The buttons with circled numbers can only be operated with the remote control.

- 1. POWER (ON/STANDBY) Button [page 15]**
- 2. Disc loading tray**
- 3. PLAY Button [page 15]**
- 4. STOP Button [page 15]**
- 5. PAUSE Button [page 15]**
- 6. Cursor Buttons [page 15]**  
Use when making settings while watching the display on a TV screen.
- 7. MENU Button [page 15]**
- 8. ENTER Button [page 15]**
- 9. ►► (SKIP) Button [page 17]**  
Plays back from the beginning of the next chapter or track.
- 10. ►► (FWD) Button [page 16]**  
Press more than 2 seconds when you use the front panel button for this function.
- 11. ◀◀ (SKIP) Button [page 17]**  
Plays back from the beginning of the current chapter or track.
- 12. ◀◀ (REV) Button [page 16]**  
Press more than 2 seconds when you use the front panel button for this function.
- 13. OPEN/CLOSE Button [page 15]**
- 14. FL OFF Button [page 15]**
- 15. Panel Display, Remote Sensor Window**
- 16. SEARCH MODE Button [page 17]**
- 17. A-B REPEAT Button [page 18]**
- 18. REPEAT Button [page 18]**
- 19. RANDOM Button [page 19]**
- 20. CLEAR Button [page 17]**
- 21. SETUP Button [page 24]**
- 22. RETURN Button [page 15]**
- 23. ANGLE Button [page 23]**  
Press to change the camera angle to see the sequence being played back from a different angle.
- 24. SUBTITLE Button [page 23]**  
Press to select a desired subtitle language.
- 25. AUDIO Button [page 22]**  
Press to select a desired audio language or sound mode.
- 26. ZOOM Button [page 16]**
- 27. DISPLAY Button [page 21]**
- 28. MODE Button [page 18]**
- 29. TOP MENU Button [page 15]**
- 30. Numeric Buttons [page 15]**
- 31. FL OFF Indicator**  
This indicator lights when the FL OFF button is ON.
- 32. STANDBY Indicator**  
This indicator lights when the DVD player turns off.
- 33. VIRTUAL Button [page 24]**







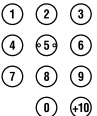



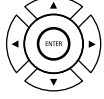

**Tour of the Remote Control**

Buttons on remote control work in different ways for DVD, Video CD, Audio CD, MP3, JPEG, WMA and DivX®. Refer to the following table for correct use.

	DVD	VCD	CD, MP3, JPEG, WMA	DivX®
<b>POWER Button</b> <small>POWER</small> 	<ul style="list-style-type: none"> <li>To turn on or to standby the unit.</li> </ul>	<ul style="list-style-type: none"> <li>To turn on or to standby the unit.</li> </ul>	<ul style="list-style-type: none"> <li>To turn on or to standby the unit.</li> </ul>	<ul style="list-style-type: none"> <li>To turn on or to standby the unit.</li> </ul>
<b>A-B REPEAT Button</b> <small>A-B</small> 	<ul style="list-style-type: none"> <li>To mark a segment between A and B for repeated playback.</li> </ul>	<ul style="list-style-type: none"> <li>To mark a segment between A and B for repeated playback.</li> </ul>	<ul style="list-style-type: none"> <li>To mark a segment between A and B for repeated playback. (CD)</li> </ul>	<ul style="list-style-type: none"> <li>To mark a segment between A and B for repeated playback.</li> </ul>
<b>REPEAT Button</b> <small>REPEAT</small> 	<ul style="list-style-type: none"> <li>To repeat playback of a title, chapter, group or track.</li> </ul>	<ul style="list-style-type: none"> <li>To repeat playback of a track or disc.</li> </ul>	<ul style="list-style-type: none"> <li>To repeat playback of a track or disc. (CD)</li> <li>To repeat playback of a track, group, or disc. (MP3, JPEG, WMA)</li> </ul>	<ul style="list-style-type: none"> <li>To repeat playback of a track, group or disc.</li> </ul>
<b>RANDOM Button</b> <small>RANDOM</small> 	—	—	<ul style="list-style-type: none"> <li>To play back tracks in random order.</li> </ul>	—
<b>MODE Button</b> <small>MODE</small> 	<ul style="list-style-type: none"> <li>To activate the 3D sound (Virtual Surround system).</li> </ul>	<ul style="list-style-type: none"> <li>To activate the 3D sound (Virtual Surround system).</li> </ul>	<ul style="list-style-type: none"> <li>To programme a specific playback order.</li> <li>To activate the 3D sound (Virtual Surround system). (CD, MP3, WMA)</li> <li>To activate the Slide Show Mode. (JPEG)</li> </ul>	—
<b>ZOOM Button</b> <small>ZOOM</small> 	<ul style="list-style-type: none"> <li>To magnify part of the picture (x2/x4).</li> </ul>	<ul style="list-style-type: none"> <li>To magnify part of the picture (x2).</li> </ul>	<ul style="list-style-type: none"> <li>To magnify part of the picture (x2). (JPEG)</li> </ul>	<ul style="list-style-type: none"> <li>To magnify part of the picture (x2).</li> </ul>
<b>ANGLE Button</b> <small>ANGLE</small> 	<ul style="list-style-type: none"> <li>To access various camera angles on the disc.</li> </ul>	—	—	—
<b>SUBTITLE Button</b> <small>SUBTITLE</small> 	<ul style="list-style-type: none"> <li>To select a subtitle language on the disc.</li> </ul>	—	—	<ul style="list-style-type: none"> <li>To select a subtitle language on the disc.</li> </ul>
<b>AUDIO Button</b> <small>AUDIO</small> 	<ul style="list-style-type: none"> <li>To access various audio functions on the disc.</li> </ul>	<ul style="list-style-type: none"> <li>To select STEREO, L-ch or R-ch.</li> </ul>	<ul style="list-style-type: none"> <li>To select STEREO, L-ch or R-ch. (CD)</li> </ul>	<ul style="list-style-type: none"> <li>To access various audio functions on the disc.</li> </ul>
<b>DISPLAY Button</b> <small>DISPLAY</small> 	<ul style="list-style-type: none"> <li>To display the current disc mode.</li> </ul>	<ul style="list-style-type: none"> <li>To display the current disc mode.</li> </ul>	<ul style="list-style-type: none"> <li>To display the current disc mode.</li> </ul>	<ul style="list-style-type: none"> <li>To display the current disc mode.</li> </ul>
<b>SEARCH MODE Button</b> <small>SEARCH MODE</small> 	<ul style="list-style-type: none"> <li>To search for a chapter, title, time or marker.</li> </ul>	<ul style="list-style-type: none"> <li>To search for a track, time or marker.</li> </ul>	<ul style="list-style-type: none"> <li>To search for a track.</li> <li>To search for time or a marker. (CD)</li> </ul>	<ul style="list-style-type: none"> <li>To search for a track or time.</li> </ul>
<b>OPEN/CLOSE Button</b> <small>OPEN / CLOSE</small> 	<ul style="list-style-type: none"> <li>To open or close the disc tray.</li> </ul>	<ul style="list-style-type: none"> <li>To open or close the disc tray.</li> </ul>	<ul style="list-style-type: none"> <li>To open or close the disc tray.</li> </ul>	<ul style="list-style-type: none"> <li>To open or close the disc tray.</li> </ul>
<b>Numeric Buttons</b> 	<ul style="list-style-type: none"> <li>To select a chapter, title or group directly.</li> </ul>	<ul style="list-style-type: none"> <li>To select a track directly.</li> </ul>	<ul style="list-style-type: none"> <li>To select a track directly.</li> </ul>	<ul style="list-style-type: none"> <li>To select a track directly.</li> </ul>

Tour of the Remote Control

	DVD	VCD	CD, MP3, JPEG, WMA	DivX®
<b>CLEAR Button</b> 	<ul style="list-style-type: none"> <li>To clear the markers.</li> <li>To clear the numbers entered incorrectly.</li> <li>To cancel the A point for A-B Repeat.</li> </ul>	<ul style="list-style-type: none"> <li>To clear the markers.</li> <li>To clear the numbers entered incorrectly.</li> <li>To cancel the A point for A-B Repeat.</li> </ul>	<ul style="list-style-type: none"> <li>To clear the markers. (CD)</li> <li>To clear the numbers entered incorrectly.</li> <li>To cancel the A point for A-B Repeat. (CD)</li> </ul>	<ul style="list-style-type: none"> <li>To clear the numbers entered incorrectly.</li> <li>To cancel the A point for A-B Repeat.</li> </ul>
<b>MENU Button</b> 	<ul style="list-style-type: none"> <li>To call up the menu on a disc.</li> </ul>	—	<ul style="list-style-type: none"> <li>To call up the FILE LIST. (MP3, JPEG, WMA)</li> </ul>	<ul style="list-style-type: none"> <li>To call up the FILE LIST.</li> </ul>
<b>TOP MENU Button</b> 	<ul style="list-style-type: none"> <li>To call up the top menu on a disc.</li> </ul>	—	<ul style="list-style-type: none"> <li>To return to the first item in the highest hierarchy of the FILE LIST. (MP3, JPEG, WMA)</li> </ul>	<ul style="list-style-type: none"> <li>To return to the top file in the highest hierarchy of the FILE LIST.</li> </ul>
<b>ENTER, Cursor Buttons</b> 	<ul style="list-style-type: none"> <li>To move the cursor and determine its position.</li> </ul>	<ul style="list-style-type: none"> <li>To move the cursor and determine its position.</li> </ul>	<ul style="list-style-type: none"> <li>To move the cursor and determine its position.</li> </ul>	<ul style="list-style-type: none"> <li>To move the cursor and determine its position.</li> </ul>
<b>RETURN Button</b> 	<ul style="list-style-type: none"> <li>To return to the previous operation in the setup menu.</li> </ul>	<ul style="list-style-type: none"> <li>To return to the previous operation in the setup menu.</li> </ul>	<ul style="list-style-type: none"> <li>To return to the previous operation in the setup menu.</li> </ul>	<ul style="list-style-type: none"> <li>To return to the previous operation in the setup menu.</li> </ul>
<b>SETUP Button</b> 	<ul style="list-style-type: none"> <li>To call up the setup menu.</li> </ul>	<ul style="list-style-type: none"> <li>To call up the setup menu.</li> </ul>	<ul style="list-style-type: none"> <li>To call up the setup menu.</li> </ul>	<ul style="list-style-type: none"> <li>To call up the setup menu.</li> </ul>
<b>SKIP Buttons</b> 	<ul style="list-style-type: none"> <li>To skip chapters/titles.</li> </ul>	<ul style="list-style-type: none"> <li>To skip tracks.</li> </ul>	<ul style="list-style-type: none"> <li>To skip tracks.</li> </ul>	<ul style="list-style-type: none"> <li>To skip tracks.</li> </ul>
<b>REV / FWD Buttons</b> 	<ul style="list-style-type: none"> <li>To search forward/backward through a disc.</li> <li>To begin slow forward/slow reverse.</li> </ul>	<ul style="list-style-type: none"> <li>To search forward/backward through a disc.</li> <li>To begin slow forward.</li> </ul>	<ul style="list-style-type: none"> <li>To begin fast forward/reverse search. (except JPEG)</li> </ul>	<ul style="list-style-type: none"> <li>To search forward/backward through a disc.</li> <li>To begin slow forward.</li> </ul>
<b>STOP Button</b> 	<ul style="list-style-type: none"> <li>To stop playback.</li> </ul>	<ul style="list-style-type: none"> <li>To stop playback.</li> </ul>	<ul style="list-style-type: none"> <li>To stop playback.</li> </ul>	<ul style="list-style-type: none"> <li>To stop playback.</li> </ul>
<b>PLAY Button</b> 	<ul style="list-style-type: none"> <li>To begin playback.</li> </ul>	<ul style="list-style-type: none"> <li>To begin playback.</li> </ul>	<ul style="list-style-type: none"> <li>To begin playback.</li> </ul>	<ul style="list-style-type: none"> <li>To begin playback.</li> </ul>
<b>PAUSE Button</b> 	<ul style="list-style-type: none"> <li>To pause playback.</li> <li>To advance playback frame by frame.</li> </ul>	<ul style="list-style-type: none"> <li>To pause playback.</li> <li>To advance playback frame by frame.</li> </ul>	<ul style="list-style-type: none"> <li>To pause playback.</li> </ul>	<ul style="list-style-type: none"> <li>To pause playback.</li> <li>To advance playback frame by frame.</li> </ul>

Panel Display

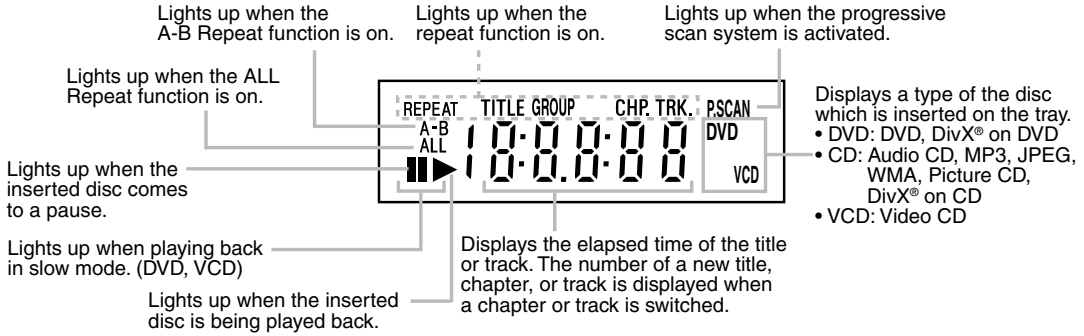

Displays during Operation

	Power on
	No disc inserted or cannot read
	Tray open
	Tray closed
	Loading the Disc
	Lights up when the playback control is activated (VCD)
	Power off

Using the Remote Control

Keep in mind the following when using the remote control:

- Make sure that there is no obstacle between the remote control and the remote sensor on the unit.
- Use within the operating range and angle, as shown.

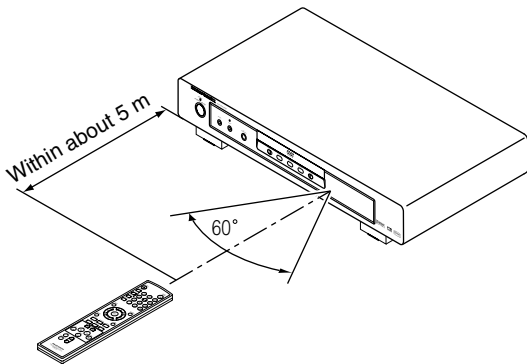

Loading the Batteries

1. Open the battery compartment cover.



2. Insert two "AA" (R6P) batteries, with each one oriented correctly.



3. Close the cover.



Cautions On Batteries

- Use "AA" (R6P) batteries in this remote control unit.
- Replace the batteries with new ones approximately once a year, though this depends on the frequency with which the remote control unit is used.
- If the remote control unit does not operate close to the main unit, replace the batteries with new ones, even if less than a year has passed.
- The included batteries are only for verifying operation. Replace them with new batteries as soon as possible.
- When inserting the batteries, be careful to do so in the proper direction, following the ⊕ and ⊖ marks in the remote control unit's battery compartment.
- To prevent damage or battery fluid leakage:
  - Do not use a new battery with an old one.
  - Do not use two different types of batteries such as alkaline and manganese.
  - Do not short-circuit, disassemble, heat or dispose of batteries in flames.
- Remove the batteries when not planning to use the remote control unit for a long period of time.
- If the batteries should leak, carefully wipe off the fluid from the inside of the battery compartment, then insert new batteries.

Description - Rear Panel

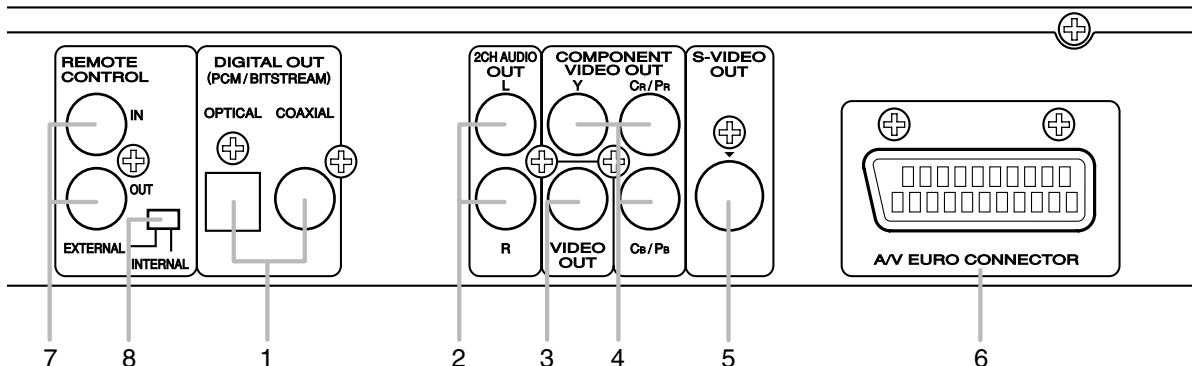

**1. DIGITAL OUT Jacks**

Use either an optical or coaxial digital cable to connect to an AV amplifier.

**2. 2CH AUDIO OUT Jacks**

Connect to the Audio input jacks of your TV or Stereo system.

**3. VIDEO OUT Jack**

Use a video cable to connect the jack to the Video input jack of your TV or Stereo system.

**4. COMPONENT VIDEO OUT Jacks**

Use these jacks if you have a TV with Component Video input jacks. These jacks provide Cr/Pr, Cb/Pb and Y video. Component Video provides the best picture quality.

**5. S-VIDEO OUT Terminal**

Use the S-Video cable to connect this terminal to the S-Video input terminal of your TV for higher picture quality.

**6. A/V EURO CONNECTOR**

Connect to the 21-pin Scart jack of a TV.

**7. REMOTE CONTROL IN/OUT Jacks**

By connecting this DVD player to another Marantz audio component using a supplied Remote control bus cable, you can remotely operate the components as a signal system.

**8. REMOTE CONTROL EXTERNAL / INTERNAL Switch**

Set this switch to "INTERNAL" when using this DVD player in a system with a Marantz receiver equipped with a remote sensor, set the switch to "EXTERNAL".

**NOTES:**

- Be sure not to use both the A/V EURO CONNECTOR and COMPONENT VIDEO OUT jacks for video output at the same time.
- When changing the "VIDEO OUT" setting ("SCART", "COMPONENT INTERLACE" or "COMPONENT PROGRESSIVE"), connect to a Video jack or an S-Video terminal on the TV. If the setting is changed, for example, to "COMPONENT INTERLACE" or "COMPONENT PROGRESSIVE" while the A/V EURO CONNECTOR is connected to the TV, a distorted video signal may be output.
- When connecting to a component with a remote sensor, be sure to connect the REMOTE CONTROL IN jack of this DVD player to the REMOTE CONTROL OUT jack of the component.
- When connecting to a component which is not equipped with a remote sensor, be sure to connect the component to the REMOTE CONTROL OUT jack of this DVD player.

**Selecting Progressive Scan (625p <576p> or Interlaced 625i <576i>) Playback**

- If your TV is compatible with progressive scanning (625p <576p>), connect the TV to the COMPONENT VIDEO OUT jacks of the DVD player and set "VIDEO OUT" to "COMPONENT PROGRESSIVE" in the display setting. Next, set your TV to the progressive scan mode. Refer to pages 24-25 for instructions on changing the display setting.
- If your TV is not compatible with progressive scan, set "VIDEO OUT" to "COMPONENT INTERLACE".
- Use a commercially available adaptor if the Video input jacks of your TVs or monitors are the BNC type.

**What is Progressive Scanning?**

- Unlike conventional interlace scanning, the progressive scan system provides less flickering and images in higher resolution than that of traditional (625i <576i>) television signals.

## CONNECTIONS

The following show examples of connections commonly used to connect the DVD player to the TV and other components.  
If using this DVD player to play back a DVD in a Dolby Digital 5.1 channel surround or DTS surround format, the DVD player outputs a Dolby Digital or DTS data stream from its OPTICAL or COAXIAL DIGITAL OUT jacks. By hooking the player up to a Dolby Digital or DTS decoder, you can enjoy a more convincing, realistic ambience with powerful and high-quality surround sound of a professional standard, which can be heard in movie theatres. Use an audio coaxial digital or optical cable (commercially available) for the audio connections.

### NOTES:

- Be sure to turn off the power of all components in the system before connecting another component.
- Refer to the instruction manuals for your TV, Stereo system and any other components to be connected to the DVD player.

### Connection to an Audio System

#### Method 1

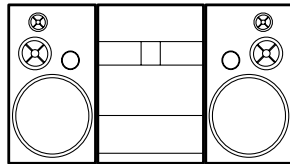

Stereo system

#### Method 2



Dolby Digital decoder,  
DTS decoder  
or  
MPEG decoder

### AUDIO

Audio Input  
Jacks

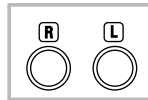

Audio Cable  
(supplied)

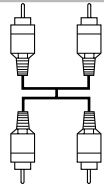

Digital Audio  
Input Jacks

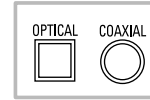

Optical Cable  
(commercially  
available)

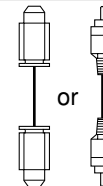

Audio Coaxial  
Digital Cable  
(commercially  
available)

### DVD

AUDIO OUT  
(Analog)



DIGITAL OUT

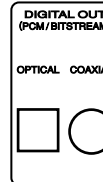

- **Method 1** DVD Player + Stereo system
- **Method 2** DVD Player + Dolby Digital decoder, DTS decoder or MPEG decoder

### NOTES (for method 2 only):

- When using an AV amplifier with a built-in decoder (Dolby Digital, DTS, or MPEG decoder) as shown in the Method 2, set "DOLBY DIGITAL", "DTS" or "MPEG" to "BITSTREAM" accordingly for audio output in the setup menu (refer to page 25). Set it to "PCM" or "OFF" for the decoder that is not used currently. Playing a DVD using incorrect settings may generate noise distortion, and may also damage the speakers.
- The audio source on a disc in a Dolby Digital 5.1 channel surround format cannot be recorded as digital sound by an MD deck or DAT deck.
- Set "DOLBY DIGITAL" and "MPEG" to "PCM", and "DTS" to "OFF" for audio output in the setup menu for connecting to an MD deck or DAT deck (refer to page 25).
- Harsh noise that could harm your ears or the speakers is generated when a DVD recorded in DTS is played while using a decoder, etc., that is not DTS-compatible.

### Optical cable (not supplied)

- Optical cable (not supplied) may be damaged when bent at sharp angles. Ensure cables are coiled in loops with a diameter of 15 cm or more when storing them.
- Use a cable which is 3m or shorter.
- Insert cable plugs firmly into the connectors when making connections.
- If a plug has dust or is dirty, clean it with a soft cloth before inserting it into a connector.

Connection to a TV (for Video)

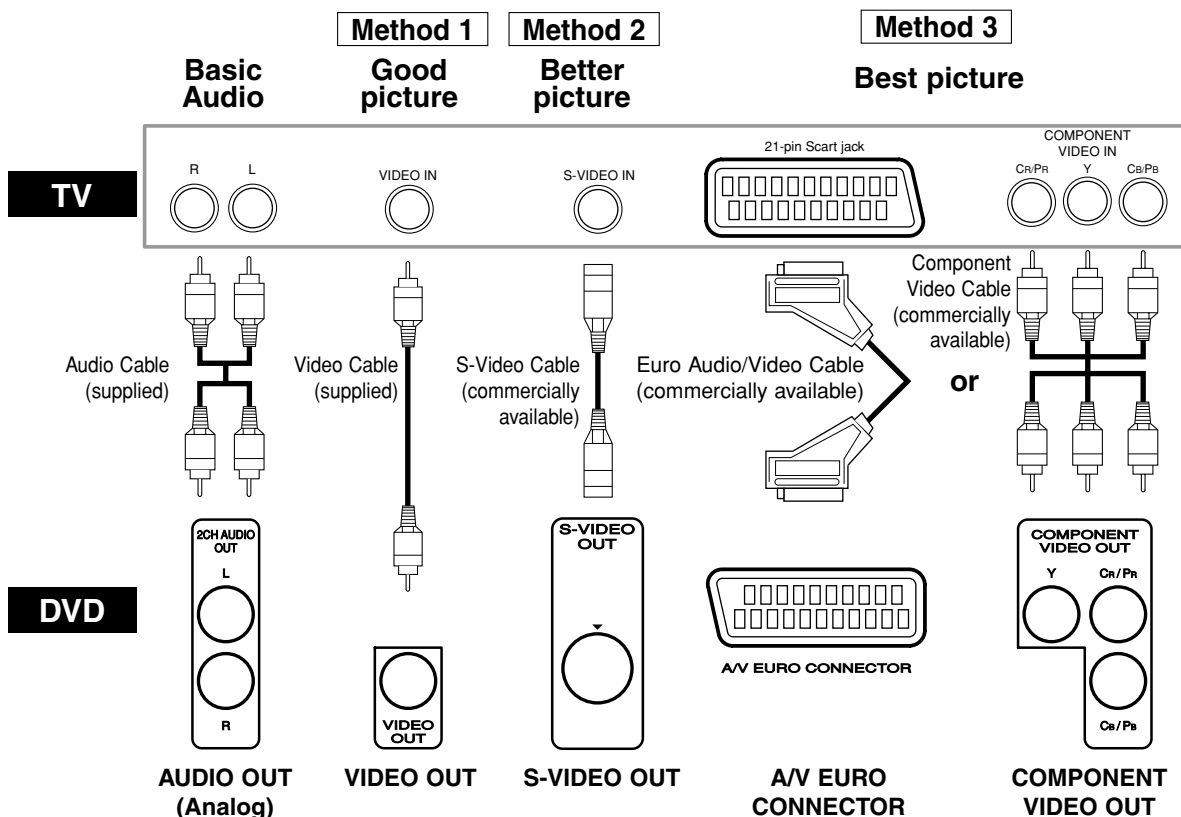

- **Method 1** DVD Player + TV with Video input jack
- **Method 2** DVD Player + TV with S-Video input terminal
- **Method 3** DVD Player + TV with AV1 (21-pin Scart) jack or Component Video input jacks

**NOTES:**

- Connect the DVD player directly to a TV. If the Audio/Video cables are connected to a VCR, pictures may be distorted due to the copy protection system.
- S-Video output terminal  
The video signals are divided into colour (C) and brightness (Y) signals, achieving a clearer picture. If the TV is equipped with an S-Video input terminal, we recommend connecting it to this unit's S-Video output terminal using a commercially available S-Video connection cord.

**HOW TO CONNECT TO A TV WITHOUT AUDIO/VIDEO INPUT JACKS**

If your TV does not have RCA type audio and video input jacks it is still possible to connect this DVD player to your TV's 75-ohm coaxial antenna terminal using an optional Stereo Audio/Video RF Modulator (not included). Connect the audio and video outputs of the DVD player to the audio and video inputs on the RF Modulator, and then connect the coaxial output of the RF Modulator (usually marked "TO TV") to the 75 ohm coaxial antenna terminal on your TV. Follow the instruction supplied with the RF Modulator for more details.

If your TV's 75 ohm coaxial antenna terminal is already occupied by an antenna or cable box connection, remove that cable from your TV's antenna terminal and reconnect it to the coaxial antenna input terminal of the RF Modulator (usually marked "ANT IN"), then connect the RF modulator to your TV's antenna terminal as described above.

**NOTE:**

- The picture quality from DVD discs will not be as good if the DVD player is connected to the TV's antenna terminal through an RF Modulator.

## Basic Playback

DVD-V	DVD-RW	VCD	CD	MP3
JPEG	WMA	DivX®		

## Getting started

- Turn on the power of the TV, amplifier and any other components which are connected to the DVD player.
- Make sure the TV and audio receiver (commercially available) are set to the correct channel.

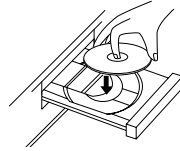

- 1 Press the **POWER** button.
  - "P-ON" will appear briefly on the display panel.
- 2 Press the **OPEN/CLOSE** button to open disc loading tray.
- 3 Place the disc in the tray, with the label facing up.
- 4 Press the **PLAY** button.
  - The tray will close automatically, and playback will start from the first chapter or track of the disc. If the playback does not start automatically, press the **PLAY** button.
  - When you play back the DVD with a title menu, it may appear on the screen. In this case, refer to "Title Menu".
- 5 Press the **STOP** button to stop playback.

## NOTES:

- A "prohibited icon" may appear at the top-right on the TV screen during operation, warning that a prohibited operation has been done to the DVD player or the disc.
- With DVDs that use some titles for playback programme signals, playback may start from the second title, or it may skip these titles.
- During the playback of two layered disc, pictures may stop for a moment. This happens when the 1st layer switches to the 2nd layer. This is not a malfunction.
- The operation may vary when you playback DVDs with disc menu or Video CDs with PBC. Refer to the manual accompanying the disc for details.
- A DVD-RW disc recorded in the VR mode may freeze momentarily during playback depending on how the playlist was made and edited (deleted titles, repeated recording).



## CANCELLING AND CALLING BACK THE PBC FUNCTION

VCD

- 1 Insert a Video CD.
- 2 Press the **STOP** button.
- 3 Press the **Numeric** buttons to enter the desired track number.
  - The PBC function is now cancelled and the playback of the Video CD will start.
- 4 To call back the PBC function, press the **STOP** button twice, and then press the **PLAY** button.
  - Title menu will appear on the display.

## General Features

DVD-V

DVD may contain menus to navigate the disc and access special features. Press the appropriate **Numeric** buttons or use the **Cursor** buttons (▼/▲/▶/◀) to highlight your selection in the DVD main menu and press the **ENTER** button to confirm.

## NOTE:

- Unless stated, all operations described are based on remote control use. Some operations can be carried out using the menu bar on the TV screen.

## FL OFF Mode

- 1 Press the **FL OFF** button on the front panel to turn off the panel display.
  - The FL OFF indicator will light up.

## NOTES:

- In setup menu, the FL OFF mode is not available.
- The FL OFF mode will be released when you press the buttons listed below.

**OPEN/CLOSE** button (on both the remote and the front panel), **SETUP**, **POWER** or **DISPLAY** button (on the remote), **POWER ON/STANDBY** or **FL OFF** button (on the front panel)

## Disc Menus

DVD-V

- 1 Press the **MENU** button.
  - The DVD main menu will appear.
- 2 If the feature is not available,  symbol may appear on the TV screen.
- 3 If disc menu is available on the disc, audio language, subtitle options, chapters for the title and other options will appear for selection.
- 4 Press the **Cursor** buttons (▼/▲/▶/◀) to select an item, and the **ENTER** button to confirm selection.

## Title Menu

DVD-V

- 1 Press the **TOP MENU** button.
  - The title menu will appear.
- 2 If the feature is not available,  symbol may appear on the TV screen.
- 3 Press the **Cursor** buttons (▼/▲/▶/◀) to select an item, and the **ENTER** button to confirm selection.
  - Playback will begin at the selected title.

VCD

- 1 When playing a Video CD with PBC function, the title menu will appear automatically.
- 2 Press the **Numeric** buttons to select the desired title.
  - Playback will begin at the selected title.
- 3 Press the **RETURN** button to go back to the title menu.

## CALLING UP A MENU SCREEN DURING PLAYBACK

DVD-V

- Press the **MENU** button to call up the DVD main menu.
- Press the **TOP MENU** button to call up the title menu.

## NOTE:

- Contents of menus and corresponding menu operations may vary between discs. Refer to the manual accompanying the disc for details.

## Still / Pause

DVD-V	DVD-RW	VCD	CD	MP3
JPEG	WMA	DivX®		

- 1 During playback, press the **PAUSE** button.
  - Playback will pause and sound will be muted.
- 2 To continue playback, press the **PLAY** button.

## NOTE:

- On DVDs, set "STILL MODE" to "FIELD" on the display menu if pictures in the pause mode are blurred. (Refer to pages 24-25.)

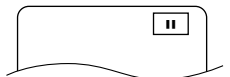

**Step by Step Playback**

DVD-V DVD-RW VCD DivX®

- 1 During playback, press the **PAUSE** button.
  - Playback will pause and sound will be muted.
- 2 The disc advances by one frame each time the **PAUSE** button is pressed.
- 3 To exit Step by Step Playback, press the **PLAY** button.



**NOTE:**

- On DVDs, set "STILL MODE" to "FIELD" on the display menu if pictures in the pause mode are blurred. (Refer to pages 24-25.)

**Resume**

DVD-V DVD-RW VCD CD MP3  
JPEG WMA DivX®

- 1 During playback, press the **STOP** button.
  - Resume message will appear on the TV screen.
- 2 Press the **PLAY** button, playback will resume from the point at which playback was stopped.
  - To cancel Resume, press the **STOP** button twice.

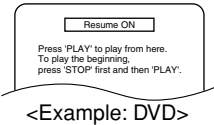

**NOTES:**

- Some Video CDs with the PBC function resume playback from the beginning of the track.
- The resume information will be saved even when the power is switched off.
- For MP3, JPEG or WMA, playback will resume from the beginning of the current track.

**Playing the Disc Recorded in VR Mode (Video Recording Format)**

DVD-RW

DVDs recorded in VR mode can have a PLAYLIST assigned to alter the order or content to be played. If a PLAYLIST has been created, you can choose the ORIGINAL or PLAYLIST option.

- 1 Press the **MENU** button in stop mode.
  - The current setting screen will appear.
  - Pressing the **MENU** button during playback is not valid.



- 2 Press the **Cursor** buttons (◀ or ▶) to select ORIGINAL or PLAYLIST.
  - PLAYLIST will not be displayed when it has not been made.
  - Resume playback will not be possible if you change the setting.
- 3 Press the **Cursor** buttons (▲ or ▼) to select a title, then press the **ENTER** button.
  - Playback will start.

**NOTE:**

- ORIGINAL: A list of titles which are recorded with a DVD recorder.
- PLAYLIST: A list of titles which is made based on the ORIGINAL edited list.

**Fast Forward / Reverse Search**

DVD-V DVD-RW VCD CD MP3  
WMA DivX®

- 1 During playback, press the **FWD** ►► or **REV** ◀◀ button repeatedly to select the required forward or reverse speed.
  - For DVDs, Fast Forward or Reverse Search speed is different depending on the disc. The approximate speed is 1 (x2), 2(x8), 3 (x20), 4 (x50) and 5 (x100).

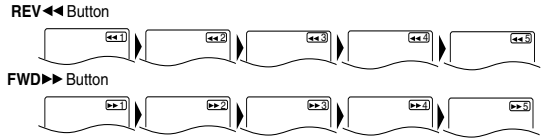

- For Video CDs, Audio CDs, MP3, WMA and DivX®, Fast Forward or Reverse Search speed is different depending on the disc. The approximate speed is 1(x2), 2(x8) or 3(x30).

- 2 To return to normal playback, press the **PLAY** button.

**NOTES:**

- Picture quality of DivX® files in fast reverse is lower than that in fast forward.
- For some DivX® files, Fast Forward/Reverse Search may not function.

**Slow Forward / Slow Reverse**

DVD-V DVD-RW VCD DivX®

- 1 During playback, press the **PAUSE** button.
- 2 Press the **FWD** ►► or **REV** ◀◀ button.

- 3 Press the **FWD** ►► or **REV** ◀◀ button repeatedly to select the required speed.
  - Slow motion playback will begin and sound will be muted.
- 4 To return to normal playback, press the **PLAY** button.

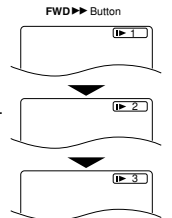

**NOTES:**

- On DVDs, set "STILL MODE" to "FIELD" on the display menu if pictures in the pause mode are blurred. (Refer to pages 24-25.)
- Only Slow Forward is available when playing Video CD and discs with DivX® files.

**Zoom**

DVD-V DVD-RW VCD JPEG DivX®

The Zoom function allows you to enlarge the video image and to pan through the enlarged image.

- 1 Press the **ZOOM** button during playback.
  - Playback will continue.
- 2 Press the **ZOOM** button repeatedly to select the required zoom factor: x2, x4 or off.
  - Only x2 zoom is available on Video CDs, JPEG and DivX®.





- 3 Use the **Cursor** buttons (▼ / ▲ / ► / ◀) to move the zoomed picture across the screen.

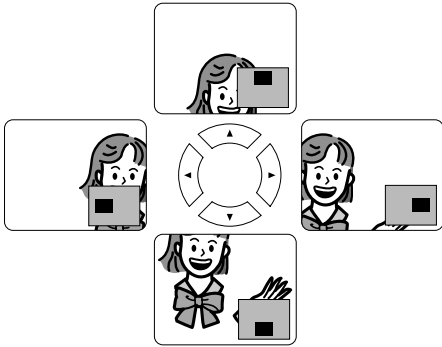

- 4 To exit Zoom mode, press the **ZOOM** button.

**NOTES:**

- Zooming function does not work while disc menu is shown.
- x4 zoom is not available on some discs.
- Playback will pause in the zoom mode on JPEG.
- Navigation screen is not available on JPEG.
- You cannot move the zoomed picture on some JPEG files.

**Title / Chapter Search**

DVD-V DVD-RW

**BY USING THE SEARCH MODE BUTTON**

- 1 Press the **SEARCH MODE** button repeatedly until the Chapter Search, or the Title Search appears during playback.
- 2 Enter the desired chapter/title number with the **Numeric** buttons.

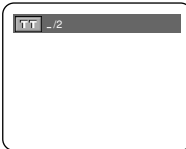
**BY USING THE SKIP BUTTONS ◀◀ ▶▶**

During playback, press the **SKIP ▶▶** button to move to the next chapter. Press it repeatedly to skip subsequent chapters. Press the **SKIP ◀◀** button to go back to the beginning of the current chapter. Press it repeatedly to go to the previous chapter.

- Chapter number will appear briefly on the front panel display.
- If the **SKIP ◀◀** or **▶▶** button is pressed while the playback is paused, the playback after skipping to the next chapter will be also paused.

**NOTES:**

- Depending on the disc being played, the **Numeric** buttons can be used to search for a desired chapter by entering the chapter number directly. Refer to the manual accompanying the disc.
- The **SKIP ◀◀** and **▶▶** buttons are not available when playback is stopped.
- A disc that does not contain chapters within titles, the **SKIP ◀◀** and **▶▶** buttons change the titles.

**Track Search**

VCD CD MP3 JPEG WMA DivX®

There are three ways to begin playback on a disc at a specific track.

**BY USING THE SEARCH MODE BUTTON**

- 1 Press the **SEARCH MODE** button.
  - The Track Search display appears.
- 2 Within 30 seconds, select a desired track number using the **Numeric** buttons.
  - For the disc with less than 10 tracks, press the track number directly.
  - For discs with 10 or more but less than 100 tracks, to play a single-digit track, press **0** first, then the track number (e.g. for track 3, press **0, 3**). To play a double-digit track, press the track number.
  - For discs with 100 or more tracks, to play a single- or a double-digit track, press **0** first, then the track number (e.g. for track 3, press **0, 0, 3**, and for track 26, press **0, 2, 6**). To play a triple-digit track, press the track number.
  - Press the **CLEAR** button to erase the incorrect input.

**NOTE:**

- The **+10** button can also bring up the Track Search display except for the disc with less than 10 tracks. For such a disc, Track Search can be done by just pressing the track number.

**BY USING THE SKIP BUTTONS ◀◀ ▶▶**

During playback, press the **SKIP ▶▶** button to move to the next track. Press it repeatedly to skip subsequent tracks. Press the **SKIP ◀◀** button to go back to the beginning of the current track. Press it repeatedly to go to the previous tracks.

- Track number will appear briefly on the panel display.
- If the **SKIP ◀◀** or **▶▶** button is pressed while the playback is paused, the playback will be also paused after skipping to the next track.

**NOTE:**

- The **SKIP ◀◀** and **▶▶** buttons are not available when playback is stopped.

**Time Search**

DVD-V DVD-RW VCD CD DivX®

- 1 During playback, press the **SEARCH MODE** button until the Time Search screen appears on the TV screen.
- 2 Within 30 seconds, enter a desired disc time with the **Numeric** buttons.
  - Playback will start at the specified time.
  - For Time Search, "0" appears automatically when there is no need to enter a number. For example, "0:0 \_ : \_" appears in the Time Search screen if the total time of the disc is less than 10 minutes.
  - Press the **CLEAR** button to erase the incorrect input.

**NOTE:**

- For some DivX® files, Time Search may not function.

**Repeat**

- The **REPEAT** button is available only during playback.

**REPEAT TITLE / CHAPTER**

**DVD-V**

To activate the Repeat function, press the **REPEAT** button during playback.

- The Repeat mode changes as described below every time you press the button.

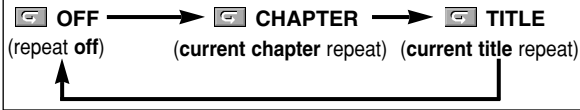

**DVD-RW**

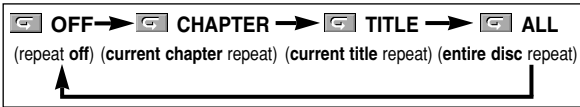

**NOTES:**

- The Repeat Title/Chapter setting will be cleared when moving to other title or chapter.
- Repeat playback does not function during A-B Repeat playback.
- Repeat Title/Chapter is not available with some scenes.
- "ALL" is not displayed when playing the DVD-RW discs recorded in Video mode.

**REPEAT TRACK / GROUP / ALL**

**VCD CD**

To activate the Repeat function, press the **REPEAT** button during playback.

- The Repeat mode changes as described below every time you press the button.

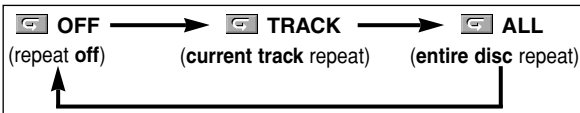

**NOTES:**

- The Repeat Track setting will be cleared when moving to other track.
- Repeat playback does not function during A-B Repeat playback.
- Repeat playback is not available when playing the Video CD with PBC function.

**MP3 JPEG WMA DivX®**

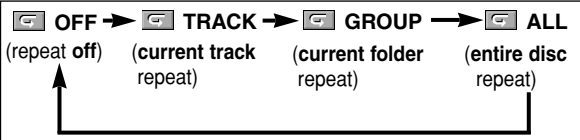

**NOTE:**

- The Repeat Track/Group setting will be cleared when moving to other track or group.

**A-B REPEAT**

**DVD-V DVD-RW VCD CD DivX®**

- 1 Press the **A-B REPEAT** button at your chosen starting point.

- **A-** appears briefly on the TV screen.

- 2 Press the **A-B REPEAT** button again at your chosen end point.

- **A-B** appears briefly on the TV screen, and the repeat sequence begins.

- 3 To exit the sequence, press the **A-B REPEAT** button.

**NOTES:**

- The A-B Repeat section can only be set within the current title (for DVD), or current track (for Video CD, Audio CD and disc with DivX® files).
- A-B Repeat is not available with some scenes in DVD.
- To cancel the A point which was set, press the **CLEAR** button.
- A-B Repeat playback does not function during title, chapter, track or all repeat playback.
- For some DivX® files, A-B Repeat playback may not function.

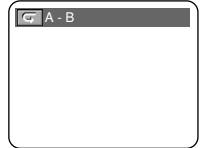

**Programme Playback**

This function allows you to programme a playback order in a desired sequence.

**CD**

- 1 In stop mode, press the **MODE** button.

- The **PROGRAM** screen will appear.

- 2 Press the **Cursor** buttons (**▲** or **▼**) to select a track, then press the **ENTER** button.

- Press the **CLEAR** button to erase the most recently entered track.

- 3 Press the **PLAY** button to start programmed playback.

**NOTES:**

- While the programme is being played back, the **STOP** button works as follows.
- Press the **STOP** button once and then the **PLAY** button again. Playback will restart from the point where the **STOP** button was pressed. (Programme continued.)
- Press the **STOP** button twice and then the **PLAY** button again. Playback will restart from the first track in the usual way. Your programmes will be stored unless either the disc tray is opened or power is turned off.
- Up to 99 tracks can be entered.
- To erase all tracks in the programme at once, select **ALL CLEAR** at the bottom of the list at step 2.
- If you wish to repeat the current track in the programme, press the **REPEAT** button repeatedly until **TRACK** appears during playback. If you wish to repeat the entire programme, press the **REPEAT** button repeatedly until **ALL** appears during playback.
- Refer to page 22 for Programme Playback of MP3, WMA, and JPEG.
- If eight or more tracks have been set in a programme, the user can switch the right part of the screen with the **SKIP** **◀◀** or **▶▶** button.

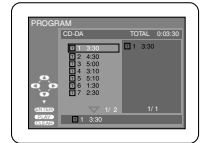

**Random Playback**

This shuffles the playing order instead of playback in the original sequence.

CD

- 1 In stop mode, press the **RANDOM** button.
  - The RANDOM screen will appear.
- 2 Press the **PLAY** button to start Random Playback.

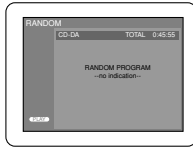

**NOTES:**

- If you wish to repeat the current track in the random selection, press the **REPEAT** button repeatedly until **TR** appears during playback. If you wish to repeat the entire random selection press the **REPEAT** button repeatedly until **ALL** appears during playback.
- You cannot go back to the previous track during Random Playback.
- Refer to page 22 for Random Playback of MP3, WMA, and JPEG.

**MP3 / JPEG / WMA Playback**

**MP3** **JPEG** **WMA**

When a CD-R or CD-RW disc with MP3, JPEG or WMA files is inserted in the DVD player and the **MENU** button is pressed, the FILE LIST will appear on the display. The number of tracks is also displayed on the front panel.

- 1 Press the **Cursor** buttons (**▲** or **▼**) to select the desired group (folder) or track.
  - If a group (folder) is selected, press the **Cursor** button (**▶**) or **ENTER** button to go on to the track selection screen. Press the **Cursor** buttons (**▲** or **▼**) to choose a track, then press the **PLAY** or **ENTER** button.
  - To return to the previous screen, press the **Cursor** button (**◀**).
  - If a track is selected, press the **PLAY** or **ENTER** button. The selected track and the subsequent tracks will be played back.
  - When selecting the folders:
    - Press the **Cursor** button (**▶**) when you want to go to the next hierarchy.
    - Press the **Cursor** button (**◀**) button when you want to go back to the previous hierarchy (except for the top hierarchy).
  - Press the **TOP MENU** button to return to the first item.
- 2 Press the **STOP** button to stop playback.

**NOTES:**

- Folders are known as groups; files are known as tracks.
- A symbol of "☐" is shown on the top of the group name.
- A symbol of "📁" is shown on the top of MP3 files.
- A symbol of "🖼️" is shown on the top of JPEG files.
- A symbol of "🎵" is shown on the top of WMA files.
- Maximum of 255 folders can be recognised.
- If the track extends beyond the scope of screen, a down arrow "▼" appears, indicating that the user can view another part on the previous page. The current page number and the number of total pages are shown on the right of the down arrow "▼". Use the **SKIP** **◀◀** or **▶▶** button to view the previous or next page.
- Maximum of 999 files can be recognised.
- Up to 8 hierarchies can be recognised.
- If no MP3, JPEG or WMA files are found in the group, the group is not displayed.
- The DVD player can reproduce data recorded as per ISO 9660 Level 1, Level 2 or Joliet on the disc.
- It can also run a disc on which data is recorded in a multi-session.

- For more details of recording systems, refer to the instruction manual for the CD-R/CD-RW drive or the writing software.
- For MP3 and WMA file recorded in Variable Bit Rate (VBR), the unit may not display the actual elapsed time.

This player recommends the use of files recorded at the below specifications:

Applicable MP3 file		Remarks
Sampling frequency	44.1kHz 48kHz	• It is prohibited to record MP3 sound on a digital device when connection is made digitally.
Type	MPEG1 audio layer 3	• MP3 files recorded at fixed bit rate of 32 kbps to 320 kbps are recommended.

Applicable JPEG file		Remarks
Size of image	Upper limit: 6300x5100 dots Lower limit: 32x32 dots	• A JPEG image that extends beyond the screen is reduced so that it will be displayed within the screen.

Applicable WMA file		Remarks
Sampling frequency	44.1kHz 48kHz	• Those frequencies are applicable to WMA version 9.
Bit rate	48–192kbps	• Ensure that the copyright function is set to off when preparing a WMA disc.
Type	WMA version 9	• A prohibition symbol will appear if the user attempts to run a non-reproducible file such as copyright-protected. • Recorded in 5.1 channel format cannot be played back.

**Information on MP3, JPEG and WMA discs**

- This DVD player can play back images and sounds from data recorded in MP3, JPEG and WMA formats on CD-R and CD-RW discs.
- A file with an extension of ".mp3 (MP3)" is called an "MP3 file".
- A file with an extension of ".jpg (JPG)" or ".jpeg (JPEG)" is called a "JPEG file".  
The DVD player can run an image file conforming to the Exif specification. Exif is a file format, Exchangeable Image File format established by Japanese Electronic Industry Development Association (JEIDA).
- A file with an extension of ".wma (WMA)" is called a "WMA file".
- Files whose extension is other than ".mp3 (MP3)", ".jpg (JPG)" and ".jpeg (JPEG)" or ".wma (WMA)" will not be listed in the MP3, JPEG or WMA menu.
- If the file is not recorded in MP3, JPEG or WMA format, noise may be produced even if the file extension is either ".mp3 (MP3)", ".jpg (JPG)", ".jpeg (JPEG)" or ".wma (WMA)".
- The name of group and track can be displayed in up to 25 characters. Unrecognisable characters will be replaced with asterisks. The ninth and deeper hierarchies cannot be displayed.
- Unplayable groups or tracks may be displayed depending on the recording conditions.
- If the **TOP MENU** button is pressed when FILE LIST is displayed, the first item will be highlighted.

### Kodak Picture CD

The DVD player can also run JPEG files stored on Kodak Picture CDs. The Picture CD is a service to convert photographs taken by a conventional film camera into digital data and write the data on a CD. The user can enjoy picture images on the television set by playing back the Picture CDs. For details of Kodak Picture CD, contact a shop that deals with developing service of Kodak Inc.

#### 1 Press the **MENU** button.

Kodak Picture CD menu appears.

- If all menu items cannot be displayed in the screen scope, "▶▶" appears at the right bottom of the screen, indicating that the user can view remaining items on the next page. "◀◀" appears, it indicates that the user can view other items on the previous page. The track number of the currently highlighted item and the total tracks are shown at the centre bottom of the screen.
- If "▶▶" is shown at the right bottom, use the **SKIP ▶▶** button to view the next page. If "◀◀" is shown at the left bottom, use the **SKIP ◀◀** button to view the previous page.
- Press the **TOP MENU** button to get back to the first page.
- It may take some time until all menu items are displayed on the menu screen.

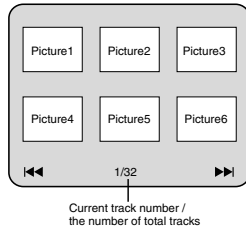

#### 2 Press the **Cursor** buttons (▼ / ▲ / ► / ◀), select a desired track to be played, then press the **PLAY** or **ENTER** button.

- If a Kodak Picture CD file is selected, an image will be played back from the selected track and go to the next one in turn.

#### 3 Press the **STOP** button, to stop playback.

#### Notes on JPEG and Kodak Picture CD:

- A track is displayed for 5 or 10 seconds and then the next track is displayed. Refer to page 26 for SLIDE SHOW.
- Every press on the **Cursor** button (►) will turn the image clockwise by 90 degrees when an image is displayed. A press on the **Cursor** button (◀) will turn the image counterclockwise by 90 degrees.
- To change the size of the playback image, press the **MODE** button twice. The size change mode appears on top of the TV screen during playback. Then press the **Cursor** buttons (◀ or ►) or **ENTER** button to switch between **NORMAL** (100%) and **SMALL** (95%).
- Progressive JPEGs (JPEG files saved in the progressive format) will not be played back on this DVD player.
- High resolution JPEG files take longer to be displayed.
- The size change mode may have no effect on some files (e.g. files with a small picture size).

#### Notes on WMA:

- The DVD player can reproduce data recorded as ISO 9660 level 2 with 31 characters file name included punctuation marks. The name of a file can be displayed in up to 25 characters.
- Maximum of 8 subfolders can be recognised.
- It can also display tag information of WMA 64 characters at maximum.
- A file with an extension of Joliet as Unicode format in up to 64 characters can be recognised.
- This unit cannot play back copyright protected WMA files.

### DivX® Playback

DivX®

This DVD player can play back DVD-R/RW and CD-R/RW discs recorded in DivX® Format. When a DVD-R/RW or CD-R/RW with DivX® files is inserted in the DVD player and the **MENU** button is pressed, the FILE LIST will appear. The number of tracks will be also displayed on the front panel.

#### 1 Press the **Cursor** buttons (▲ or ▼) to select the desired group (folder) or track.

- To return to the previous screen, press the **Cursor** button (◀).
- If a group (folder) is selected, press the **Cursor** button (►) or **ENTER** button to go on to the track selection screen. Press the **Cursor** buttons (▲ or ▼) to choose a track, then press the **PLAY** or **ENTER** button.
- If a track is selected, press the **PLAY** or **ENTER** button. The selected track and the subsequent tracks will be played back.
- When selecting the folders:
  - Press the **Cursor** button (►) when you want to go to the next hierarchy.
  - Press the **Cursor** button (◀) when you want to go back to the previous hierarchy (except for the top hierarchy).
- Press the **TOP MENU** button to return to the first item.

#### 2 Press the **STOP** button to stop playback.

#### NOTES:

- DivX® is a codec (compression/decompression) that can compress images to a very small amount of data. The software can compress video data from almost any sources to the size that can be sent on the Internet without compromising visual quality of the images.
- A file with an extension of ".avi" or ".divx" is called a DivX® file. All files with the ".avi" extension are recognised as MPEG 4.
- Files with the extension other than ".avi" and ".divx" will not be listed on the DivX® menu. However, unplayable groups or tracks may be displayed, depending on the recording conditions.
- Even if the file has an extension of either ".avi" or ".divx", this player cannot play it back if it is recorded in the format other than DivX®.
- Folders are known as groups; files are known as tracks.
- A symbol of [ ] is shown on the top of the group name.
- Maximum of 255 folders can be recognised.
- Maximum of 999 files can be recognised.
- If the track extends beyond the scope of screen, a down arrow "▼" appears, indicating that the user can view another part on the previous page. The current page number and the number of total pages are shown on the left of the down arrow "▼".
- The name of a group and track can be displayed up to 25 characters. Unrecognizable characters will be replaced with asterisks. The ninth and deeper hierarchies cannot be displayed.
- You can play back the disc recorded in multi-session.
- Playback will be paused if the FILE LIST is displayed during the playback.
- It may take a while for audio and images to be output after you inserted a disc and pressed the **PLAY** button.
- When playing back the files recorded in high bit rates, the images can be interrupted on some occasions.
- Although DivX® logo has been obtained for this player, it may not be able to play back some data, depending on the disc characteristics, bit rates, or audio format settings, etc.

- Use the software recognised by DivX®, Inc. when you make DivX® files.
- When using tools or utilities to make up DivX® files, read their instruction manual beforehand.
- A DivX® file whose file size exceeds 2GB cannot be played back.
- If a large-sized DivX® file is selected, it may take a while to start the playback (over 20 seconds sometimes).
- If DivX® files wrote on CD discs cannot be played back, rewrite them on a DVD disc and try to play back.
- For more information for DivX®, please visit <http://www.divx.com>.
- If you insert a CD-R/RW with DivX® files that are mixed with MP3, JPEG, or WMA files, the Playback Media Selection screen will be displayed. Please select Video and proceed to Step 1.

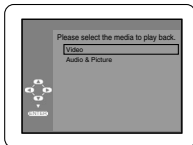

- Press the **TOP MENU** button to call up the Playback Media Selection screen in stop mode.
- If you select Audio & Picture, instead of Video on the Playback Media Selection screen, the DVD player can play back MP3/JPEG/WMA files. Refer to page 19 for details.

This player recommends the use of files recorded at the following specifications:

Applicable DivX® file		Remarks
Playable Codec of AVI files	DivX®3.1.1, DivX®4.x, DivX®5.1.1	• They are recognised as MPEG4.
Maximum size of image	720 x 480 @30 fps 720 x 576 @25fps	
Sampling frequency of audio	8 kHz - 48kHz	• It is prohibited to record MP3 sound on a digital device when the connection is made digitally.
Audio type	MPEG1 audio layer 3 (MP3) MPEG1 audio layer 2	• MP3 files recorded at fixed bit rate of 32 kbps to 320 kbps are recommended.

**Slide Show Mode**

**JPEG**

You can switch to the Slide Show Mode during playback.

- 1 Press the **MODE** button during playback.
  - The Slide Show Mode screen will appear.
  - The Slide Show Mode cannot be switched when it is stopped, or from the FILE LIST screen or the Picture CD menu screen.
- 2 Press the **Cursor** buttons (◀ or ▶) or **ENTER** button.
  - The Slide Show Mode will change.  
CUT IN/OUT: The entire image appears in one time.  
FADE IN/OUT: The image appears gradually and then disappears.
- 3 Press the **MODE** button twice to exit.

**On-Screen Information**

You can check information about the current media by pressing the **DISPLAY** button on the remote control.

**DVD-V DVD-RW**

- 1 Press the **DISPLAY** button during playback to show the current chapter.
  - The elapsed and remaining playing time of the current chapter will be displayed.
- 2 Press the **DISPLAY** button again to show the current title.
  - The elapsed and remaining playing time of the current title will be displayed.
- 3 Press the **DISPLAY** button again to show the bit rate and the current repeat setting.
  - If you are playing a dual layered disc, the layer number will also be displayed (L0: Layer 0 is played. L1: Layer 1 is played).
  - If you are playing a DVD-RW with setting the PLAYLIST, the following will also be displayed.  
ORG: Playing the ORIGINAL.  
PL: Playing the PLAYLIST.
- 4 Press the **DISPLAY** button again to remove the display.

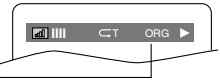

**VCD CD**

- 1 Press the **DISPLAY** button during playback, the current track will be displayed on the TV screen.
  - The elapsed and remaining playing time of the current track will be displayed.
- 2 Press the **DISPLAY** button again to show the total tracks.
  - The elapsed and remaining playing time of the disc will be displayed.
- 3 Press the **DISPLAY** button again to remove the display.
  - During Programme or Random Playback, each playback status will be displayed when you press the **DISPLAY** button. Then press the **DISPLAY** button again to remove the display.

**MP3 JPEG DivX®**

- 1 Press the **DISPLAY** button during playback.
  - The name of the file currently played will be displayed.
- 2 Press the **DISPLAY** button again to show the track number, the elapsed time (MP3 and DivX®), the repeat status, and the playback status at the top of the screen.
- 3 Press the **DISPLAY** button again to remove the display.
  - During Programme or Random Playback, each playback status will be displayed when you press the **DISPLAY** button. Then press the **DISPLAY** button again to remove the display.

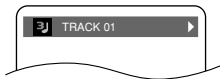

<Example: MP3>

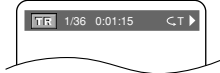

- 1** Press the **DISPLAY** button during playback.
  - The name of the file currently played will be displayed.
- 2** Press the **DISPLAY** button again.
  - Title name based on tag information currently played will be displayed.
- 3** Press the **DISPLAY** button again.
  - Artist name based on tag information currently played will be displayed.
- 4** Press the **DISPLAY** button again to show the track number, the elapsed time, the repeat status, and the playback status at the top of the screen.

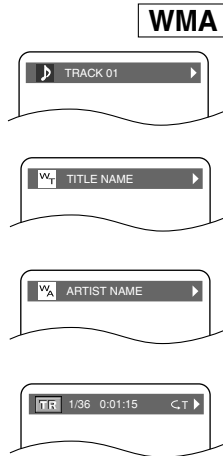

- 5** Press the **DISPLAY** button again to remove the display.
  - During Programme or Random Playback, each playback status will be displayed when you press the **DISPLAY** button. Then press the **DISPLAY** button again to remove the display.

**NOTE:**

- If the file does not contain tag information, "NOT AVAILABLE" will be displayed.

**Hints for repeat indications**

- ◁C - indicates Chapter repeat
- ◁T - indicates Title or Track repeat
- ◁G - indicates Group (folder) repeat
- ◁A - indicates Disc repeat
- A◁B - indicates A-B repeat

**Programme Playback**

MP3 JPEG WMA

This feature allows you to programme an MP3, JPEG or WMA disc to play in a desired sequence.

- 1** In stop mode, press the **MODE** button.
  - The PROGRAM screen will appear.
- 2** Press the **Cursor** buttons (▲ or ▼) to select a group, then press the **Cursor** button (▶) or **ENTER** button.
  - A track selection screen appears.
- 3** Press the **Cursor** buttons (▲ or ▼) to select a track, then press the **ENTER** button to save it in a programme.
  - Press the **CLEAR** button to erase the most recently entered track.
  - The programmed track is displayed in the right-hand screen.
  - If the entire programme cannot be displayed at once on the screen, "▼" appears to go to the next page.
  - Pressing the **Cursor** button (◀) will show a list of folders that belong to the one-level upper hierarchy than the currently selected folder.
- 4** Press the **PLAY** button to start programmed playback.

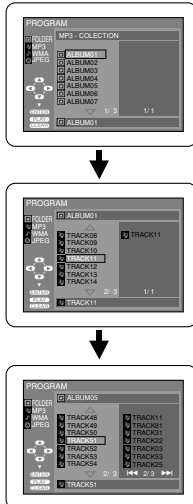

**NOTES:**

- To erase all tracks in the programme at once, select **ALL CLEAR** at the bottom of the list at step **2**.
- During the display of the PROGRAM screen, press the **RETURN** button, and the stop screen will show up with the programme contents in memory.
- Press the **STOP** button once and then the **PLAY** button again. Playback will restart from the beginning of the track played previously. (Programme continued.)
- Press the **STOP** button twice and then the **PLAY** button again. Playback will restart from the first track in the usual way. Your programmes will be stored unless either the disc tray is opened or power is turned off.
- Up to 99 tracks can be set in a programme.
- If an inserted disc contains mixed MP3, JPEG and WMA files, Programme function allows 99 tracks in combination of MP3, JPEG and WMA files.
- If eight or more tracks have been set in a programme, the user can switch the right part of the screen with the **SKIP** ◀◀ or ▶▶ button.

**Random Playback**

MP3 JPEG WMA

- 1** In stop mode, press the **RANDOM** button.
  - The RANDOM screen will appear.
- 2** Press the **PLAY** button to start Random Playback.
  - For a disc containing mixed MP3, JPEG and WMA files, Random Playback of those files will be performed.

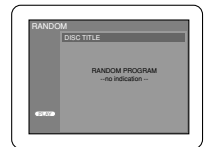

**Audio Language**

DVD-V DVD-RW DivX®

The DVD player allows you to select a language during DVD disc playback if multiple languages are available.

- 1** Press the **AUDIO** button during playback.
- 2** Press the **AUDIO** button repeatedly to select your desired language.

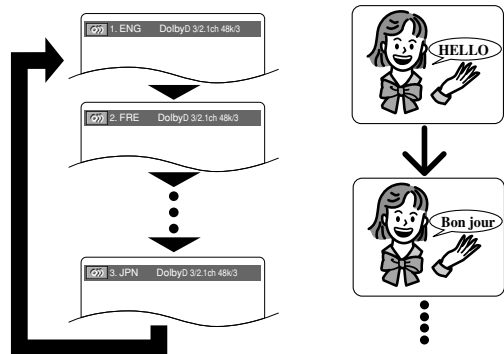

**NOTES:**

- The sound mode cannot be changed during playback of discs not recorded in double sound.
- Some discs allow Audio Language setting on the disc menu. (Operation varies between discs. Refer to the manual accompanying the disc.)
- For discs with DivX® files, the screen only displays MP3 audio or MPEG1 audio layer 2. (MPEG1 audio layer 2 will be displayed as "MP2".) Other audio sounds will be displayed as "----".
- Pressing the **AUDIO** button may not work on some DVDs with multiple audio languages (e.g. DVDs which allow Audio Language setting on the disc menu).
- If you choose a language that has a 3-letter language code, the code will be displayed every time you change the Audio Language setting. If you choose any other languages, "----" will be displayed instead. (Refer to page 27.)

## PLAYING A DISC

- If the disc has no audio language, 'NOT AVAILABLE' will be displayed.
- For DVD-RW (VR mode), pressing the **AUDIO** button cycles the sound mode through MAIN, SUB and MAIN + SUB.
- For DVD-RW (VR mode), discs recorded in double sound (two languages) can be played back in sound mode of MAIN, SUB or MAIN + SUB.
- With the digital connection, the audio language of DVD-RW (VR mode) with double sound will not be affected even though you can change the setting on the display.

### Subtitle Language

DVD-V DivX®

The DVD player allows you to select a language for subtitle during DVD disc playback if multiple languages are available.

- 1 Press the **SUBTITLE** button during playback.
- 2 Press the **SUBTITLE** button repeatedly to select your desired subtitle language.

- The selected language will be displayed on the display bar at the top of the screen.
- Press the **Cursor** buttons (◀ or ▶) to turn ON or OFF subtitles during playback.

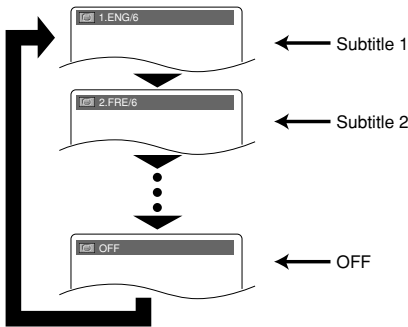

- 3 To turn off subtitles, press the **SUBTITLE** button repeatedly until OFF appears.

#### NOTES:

- Some discs allow Subtitle Language setting on the disc menu. (Operation varies between discs. Refer to the manual accompanying the disc.)
- Pressing the **SUBTITLE** button may not work on some DVDs with multiple subtitle languages (e.g. DVDs which allow Subtitle Language setting on the disc menu).
- If the desired language is not shown after pressing the **SUBTITLE** button several times, the disc does not have subtitles in that language.
- If you choose a language that has a 3-letter language code, the code will be displayed every time you change the Subtitle Language setting. If you choose any other languages, '---' will be displayed instead. (Refer to page 27.)
- If the disc has no subtitle language, 'NOT AVAILABLE' will be displayed.
- For discs with DivX® files, the screen only displays the number of subtitle languages.

### Stereo Sound Mode

VCD CD

- 1 Press the **AUDIO** button repeatedly during playback to select between STEREO, L-ch or R-ch.  
 STEREO - both right and left channels are active (stereo)  
 L-ch - only left channel is active  
 R-ch - only right channel is active

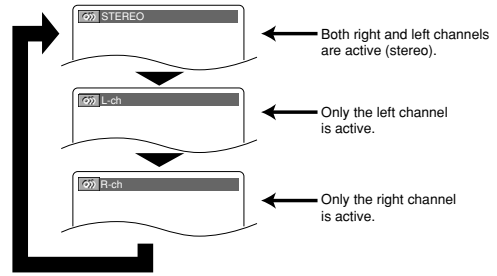

#### NOTE:

- Stereo sound mode will not be changed when playing DTS CD.

### Camera Angle

DVD-V

Some DVD discs contain scenes which have been shot simultaneously from various angles. You can change the Camera Angle when the mark (📷) appears on the screen.

- 1 Press the **ANGLE** button during playback.  
 • The selected angle will be displayed on the display bar at the top of the screen.
- 2 Press the **ANGLE** button repeatedly to select your desired angle.

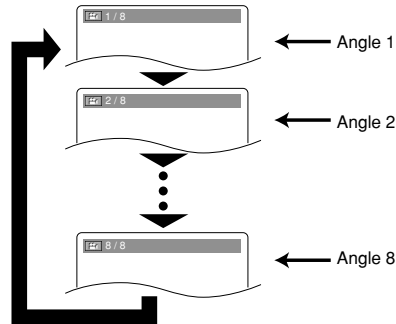

#### NOTE:

- If the "ANGLE ICON" setting is "OFF" in the display menu, the mark (📷) will not appear. (Refer to page 26.)

### Marker Setup Screen

DVD-V DVD-RW VCD CD

Use markers to memorise your favourite places on a disc.

- 1 Press the **SEARCH MODE** button repeatedly until the display screen and markers appear during playback.
- 2 Press the **Cursor** buttons (◀ or ▶) to select 1, 2, 3, 4, 5, 6, 7, 8, 9, or 10 and ensure that " : : " appears on the display.
- 3 When the disc reaches the desired point, press the **ENTER** button.  
 • The title or track and elapsed playing time will appear on the TV screen.
- 4 To return to the marker later, press the **SEARCH MODE** button repeatedly during playback and the **Cursor** buttons (◀ or ▶) to choose a desired marker, then pressing the **ENTER** button.



## PLAYING A DISC

### NOTES:

- Opening the disc tray, turning off the power or selecting AC at step 2 and pressing the **ENTER** button will erase all markers.
- To clear a marker, use the **Cursor** buttons (◀ or ▶), position the cursor on to the marker number to be cleared and press the **CLEAR** button.
- You can mark up to 10 points.

- 5 Press the **SEARCH MODE** or **RETURN** button to exit.

### Virtual Surround



You can enjoy stereophonic virtual space through your existing 2 channel stereo system.

- 1 Press the **MODE** button during playback.
- 2 Press the **Cursor** buttons (◀ or ▶) or **ENTER** button to set it 1 (Natural effect), 2 (Emphasised effect) or OFF.

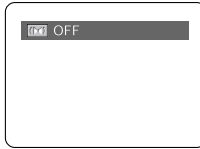

- 3 Press the **MODE** or **RETURN** button to exit.

### NOTES:

- You can also use the **VIRTUAL** button on the front panel. Press it repeatedly to select the required effect: 1, 2 or OFF.
- Select Virtual Surround OFF or adjust the volume down if the sound is distorted.
- Virtual Surround will not be effective if the sound mode is set to something other than "STEREO". (for Audio CDs or Video CDs playback only)
- The setting will be saved even if the player is turned off.

## DVD SETUP

In setup menu, QUICK mode, CUSTOM mode and INITIALIZE mode (refer to pages 24-26) are available. QUICK mode consists of the setting menus often needed, and you can make all settings required in CUSTOM mode.

You can make the settings of the items with **QUICK** mark in QUICK mode.

### Language Setting

Language options are not available with some discs.

- 1 Press the **SETUP** button in stop mode.
- 2 Press the **Cursor** buttons (◀ or ▶) to select CUSTOM, then press the **ENTER** button.
  - The CUSTOM mode will appear.
- 3 Press the **Cursor** buttons (◀ or ▶) to select LANGUAGE, then press the **ENTER** button to confirm.
- 4 Press the **Cursor** buttons (▲ or ▼) to select the below items, then press the **ENTER** button.



#### AUDIO (Default : ENGLISH)

- Sets the audio language.

#### SUBTITLE (Default : ENGLISH)

- Sets the subtitle language.

#### DISC MENU (Default : ENGLISH)

- Sets the language for DVD menu.

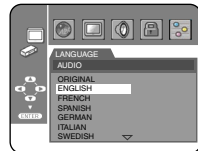

#### PLAYER MENU (Default : ENGLISH) QUICK

- Sets the language for the on-screen display.
- 5 Press the **Cursor** buttons (▲ or ▼) to select a setting, then press the **ENTER** button.
    - If OTHER is selected in the AUDIO, SUBTITLE or DISC MENU screen, press 4-digit number to enter the code for the desired language. (Refer to the Language Code List on page 27.)
    - Only the languages supported by the disc can be selected.

- 6 Press the **SETUP** button to exit.

### NOTE:

- Language Setting for AUDIO and SUBTITLE is not available with some discs. Then use the **AUDIO** and **SUBTITLE** buttons. Details are on pages 22-23.

### Display Setting

You can change certain aspects of the DVD display screens, and various display mode settings.

- 1 Press the **SETUP** button in stop mode.
- 2 Press the **Cursor** buttons (◀ or ▶) to select CUSTOM, then press the **ENTER** button.
  - The CUSTOM mode will appear.
- 3 Press the **Cursor** buttons (◀ or ▶) to select DISPLAY, then press the **ENTER** button to confirm.
- 4 Press the **Cursor** buttons (▲ or ▼) to select the below items, then press the **ENTER** button.

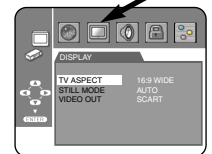

#### TV ASPECT (Default : 16:9 WIDE) QUICK

- Press the **Cursor** buttons (▲ or ▼) for an item selection, then press the **ENTER** button.
- Select 16:9 WIDE if a wide-screen TV is connected to the DVD player.
- Select 4:3 LETTER BOX for a black bars appears on top and bottom of the screen.
- Select 4:3 PAN & SCAN for a full height picture with both sides trimmed.

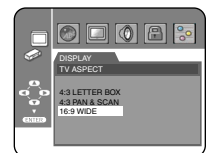

#### STILL MODE (Default : AUTO)

- Press the **Cursor** buttons (▲ or ▼) for an item selection (AUTO, FIELD, or FRAME), then press the **ENTER** button.
- This adjusts the resolution of pictures in the still (PAUSE) mode.
- If you select AUTO, automatically select the best resolution setting (FRAME or FIELD) based on the data characteristics of the pictures.

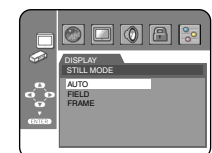



- If you select **FIELD**, pictures in the still mode will be stabilized although they will be coarse due to a little amount of data.
- If you select **FRAME**, pictures in the still mode will be highly defined although they will be blurred due to output of two fields at the same time.

**NOTE:**

- An individual picture on TV screen is called as “frame”, which consists of two separate images called as “field”. Some pictures may be blurred at the **AUTO** setting in the still mode due to their data characteristics.

**VIDEO OUT**

(Default : **SCART**)

- Press the **Cursor** buttons (▲ or ▼) for an item selection (**SCART**, **COMPONENT INTERLACE** or **COMPONENT PROGRESSIVE**), then press the **ENTER** button.
- This setting will be effective when you exit the setup screen by pressing the **SETUP** button.
- When **VIDEO OUT** is **COMPONENT PROGRESSIVE**, “P.SCAN” appears on the DVD player’s panel display after you exited the setup screen.
- Refer to page 12 for more details.

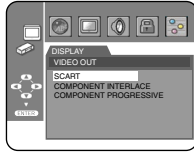

5 Press the **SETUP** button to exit.

**NOTES:**

- Be sure to press the **SETUP** button, or the setting will not work.
- When changing the **VIDEO OUT** setting (**SCART**, **COMPONENT INTERLACE** or **COMPONENT PROGRESSIVE**), connect to a **VIDEO** jack or an **S-VIDEO** terminal on the TV. If the setting is changed, for example, to **SCART** while the Component Video jacks are used to connect to the TV, a distorted video signal may be output.

**Audio Setting**

Choose the appropriate Audio Setting for your equipment as it only affects during the playback of DVD discs of the DVD player.

- 1 Press the **SETUP** button in stop mode.
- 2 Press the **Cursor** buttons (◀ or ▶) to select **CUSTOM**, then press the **ENTER** button.
  - The **CUSTOM** mode will appear.
- 3 Press the **Cursor** buttons (◀ or ▶) to select **AUDIO**, then the **ENTER** button to confirm.
- 4 Press the **Cursor** buttons (▲ or ▼) to select the below items, then press the **ENTER** button.

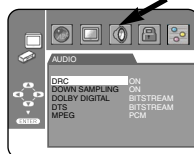

**DRC (Dynamic Range Control)**  
(Default : **ON**)

- To compress the range of sound volume.
- **DRC** function is available only on the discs that are recorded in the **Dolby Digital** format.

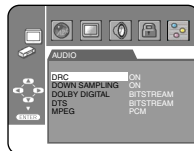

**DOWN SAMPLING (Default : ON)**

- Set to **ON** when outputting in 48kHz.
- This function is available only on digital outputting of a disc recorded in 96kHz.

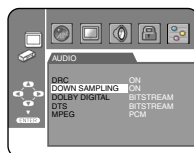

**When playing disc with copyright protection**

- The sound will be down-sampled at 48kHz, even if you set to **OFF**.

**DOLBY DIGITAL (Default : BITSTREAM) QUICK**

- Set to **BITSTREAM** when the player is connected to a **Dolby Digital** decoder.
- This function is effective only for the **COAXIAL** and **OPTICAL** connections.

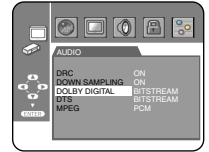

**BITSTREAM:**

Output by **Dolby Digital**.

**PCM:** Convert **Dolby Digital** to **PCM**.

**DTS (Default : BITSTREAM) QUICK**

- Set to **BITSTREAM** when the unit is connected to a **DTS** decoder.
- This function is effective only for the **COAXIAL** and **OPTICAL** connections.



**BITSTREAM:**

Output **DTS** sound.

**OFF:** No **DTS** sound will be output.

**MPEG (Default: PCM) QUICK**

- Set to **BITSTREAM** when the unit is connected to an **MPEG** decoder.
- This function is effective only for the **COAXIAL** and **OPTICAL** connections.



**BITSTREAM:**

Output **MPEG** sound.

**PCM:** Convert **MPEG** sound to **PCM**.

5 Press the **SETUP** button to exit.

**Parental Control**

**Parental Control** limits playback of discs with unsuitable audience ratings. A 4-digit password established by the user will unlock the **Parental Lock**. This feature allows you to prevent your children from playing discs with objectionable scenes.

**PARENTAL LEVEL**

**Parental Level** allows you to set the rating level of your DVD discs. Playback will stop if the disc’s ratings exceed the level you set.

- 1 Press the **SETUP** button in stop mode.
- 2 Press the **Cursor** buttons (◀ or ▶) to select **CUSTOM**, then press the **ENTER** button.
- 3 Press the **Cursor** buttons (◀ or ▶) to select **PARENTAL**, then press the **ENTER** button.
- 4 Press the **Numeric** buttons to enter your 4-digit password.
  - When doing this for the first time, enter any 4-digit number by pressing the **Numeric** buttons (except for 4737), then press the **ENTER** button. That number will be used as the password from the second time onward. Record your password in case you forget it.



- 5 Press the **Cursor** buttons (▲ or ▼) to select **PARENTAL LEVEL**, then press the **ENTER** button.
- 6 Press the **Cursor** buttons (▲ or ▼) to select the desired level, then press the **ENTER** button.

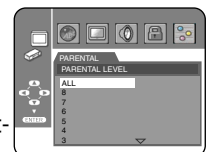
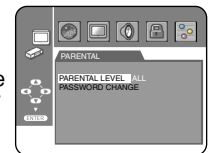

**7** Press the **SETUP** button to exit.

**NOTE:**

- This function may not work on some DVDs. Be sure if the ratings operate in the way you have set.

**To Change the Password:**

- 1) Follow the steps **1** to **4** above.
- 2) Press the **Cursor** buttons (**▲** or **▼**) to select "PASSWORD CHANGE", then press the **ENTER** button.
- 3) Enter a new 4-digit password, then press the **ENTER** button.
- 4) Press the **SETUP** button to exit.

**IF YOU FORGET THE PASSWORD**

- 1** Press **4, 7, 3, 7** at step **4**.
  - The original password will be cleared and the Parental Level will be set to "ALL". Enter a new 4-digit password, then press the **ENTER** button.
- 2** Repeat steps **5** to **7** to re-establish the Parental Level.

**CONTROL LEVELS**

- **ALL**  
Parental Lock is cancelled.
- **Level 8**  
DVD softwares of any grades (adult/general/children) can be played back.
- **Levels 7 to 2**  
Only DVD softwares intended for general use and children can be played back.
- **Level 1**  
Only DVD softwares intended for children can be played back. DVD softwares intended for adult and general use will be prohibited.

**Others Setting**

This function allows you to adjust Angle Icon availability, Auto Power Off, brightness of the player's display panel, Slide Show Mode and to obtain DivX® registration code.

- 1** Press the **SETUP** button in stop mode.
- 2** Press the **Cursor** buttons (**◀** or **▶**) to select **CUSTOM**, then press **ENTER**.
  - The **CUSTOM** mode will appear.
- 3** Press the **Cursor** buttons (**◀** or **▶**) to select **OTHERS**, then press the **ENTER** button to confirm.
- 4** Press the **Cursor** buttons (**▲** or **▼**) to select an item, then press **ENTER**.

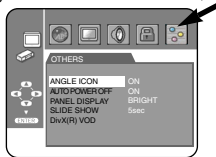

**ANGLE ICON (Default : ON)**

- Press the **ENTER** button repeatedly to turn **ANGLE ICON ON** or **OFF**.

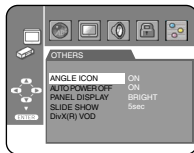

**AUTO POWER OFF (Default : ON)**

- Press the **ENTER** button repeatedly to turn **AUTO POWER OFF ON** or **OFF**.
- It will turn the DVD player off automatically after 30 minutes of no use.

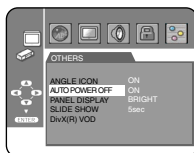

**PANEL DISPLAY (Default : BRIGHT)**

- Press the **Cursor** buttons (**▲** or **▼**) to select an item among **BRIGHT**, **DIMMER** and **AUTO**, then press the **ENTER** button.
- When **AUTO** is selected, the display dims only during playback.

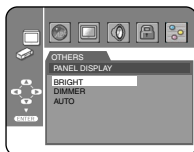

**SLIDE SHOW (Default : 5sec)**

- This adjusts the playback speed of the **JPEG SLIDE SHOW**.
- Press the **Cursor** buttons (**▲** or **▼**) to select between **5 sec** and **10 sec**, then press the **ENTER** button.

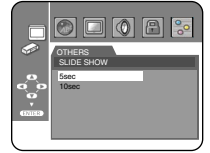

**DivX(R) VOD**

- This player allows you to use the **DivX® Video-On-Demand (VOD)** services. You can play back the files purchased or rental from the **VOD** services. You need to have a registration code to purchase or rental **VOD** files. Please visit [www.divx.com/vod](http://www.divx.com/vod) for more details.

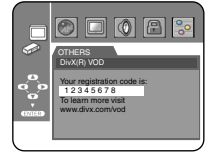

**NOTES:**

- You cannot play back the **DivX® VOD** files obtained with different registration codes on this player.
- You cannot play back the **DivX® VOD** files, of which rental period has been expired. In such case, press the **MENU** button and select other files that can be played back.
- Some **DivX® VOD** files are restricted with the limited playable times (you cannot play them back beyond the limit). If your **DivX® VOD** file has such limit, the playback confirmation screen will appear. Use the **Cursor** button (**◀** or **▶**) to select **YES** if you want to play back the file, or to select **NO** if you do not wish to play it back. Then, press the **ENTER** button to confirm the selection.
- Please send your inquiries regarding the **VOD** files to **DivX®, Inc.**

**5** Press the **SETUP** button to exit.

**Reset to the Default Settings (except for PARENTAL and VIDEO OUT)**

This allows you to return all selections of **SETUP** (except for **PARENTAL** and **VIDEO OUT**) to their default settings.

- 1** Press the **SETUP** button in stop mode.
- 2** Press the **Cursor** buttons (**◀** or **▶**) to select **INIT.**, then press the **ENTER** button.
- 3** Press the **Cursor** buttons (**▲** or **▼**) to select **YES**, then press the **ENTER** button.
- 4** Press the **SETUP** button to exit.

**NOTE:**

- If you like to cancel initializing, select **NO** at step **3**.

Language Code List

Language	Code	Language	Code	Language	Code	Language	Code
<b>A-B</b>							
Abkhazian	4748	Frisian	5271	Malay	5965	Somali	6561
Afar	4747	Galician	5358	Malayalam	5958	Spanish [SPA]	5165
Afrikaans	4752	Georgian	5747	Maltese	5966	Sundanese	6567
Albanian	6563	German [GER]	5051	Maori	5955	Swahili	6569
Amharic	4759	Greek [GRE]	5158	Marathi	5964	Swedish [SWE]	6568
Arabic	4764	Greenlandic	5758	Moldavian	5961		
Armenian	5471	Guarani	5360	Mongolian	5960	Tagalog	6658
Assamese	4765	Gujarati	5367	Nauru	6047	Tajik	6653
Aymara	4771	Hausa	5447	Nepali	6051	Tamil	6647
Azerbaijani	4772	Hebrew	5569	Norwegian [NOR]	6061	Tatar	6666
Bashkir	4847	Hindi	5455			Telugu	6651
Basque	5167	Hungarian [HUN]	5467			Thai	6654
<b>I-K</b>							
Bengali;Bangla	4860	Icelandic [ICE]	5565	Occitan	6149	Tibetan	4861
Bhutani	5072	Indonesian	5560	Oriya	6164	Tigrinya	6655
Bihari	4854	Interlingua	5547	Oromo(Afan)	6159	Tonga	6661
Bislama	4855	Interlingue	5551	Panjabi	6247	Tsonga	6665
Breton	4864	Inupiak	5557	Pashto;Pushto	6265	Turkish [TUR]	6664
Bulgarian	4853	Irish [IRI]	5347	Persian	5247	Turkmen	6657
Burmese	5971	Italian [ITA]	5566	Polish	6258	Twi	6669
Byelorussian	4851	Japanese [JPN]	5647	Portuguese [POR]	6266		
<b>C-E</b>							
Cambodian	5759	Javanese	5669	Quechua	6367	Ukrainian	6757
Catalan	4947	Kannada	5760	Rhaeto-Romance	6459	Urdu	6764
Chinese [CHI]	7254	Kashmiri	5765	Romanian [RUM]	6461	Uzbek	6772
Corsican	4961	Kazakh	5757	Russian [RUS]	6467	Vietnamese	6855
Croatian	5464	Kinyarwanda	6469			Volapuk	6861
Czech	4965	Kirghiz	5771	Samoan	6559	Welsh	4971
Danish [DAN]	5047	Kirundi	6460	Sangho	6553	Wolof	6961
Dutch [DUT]	6058	Korean [KOR]	5761	Sanskrit	6547	Xhosa	7054
English [ENG]	5160	Kurdish	5767	Scots Gaelic	5350	Yiddish	5655
Esperanto	5161			Serbian	6564	Yoruba	7161
Estonian	5166			Serbo-Croatian	6554	Zulu	7267
<b>F-H</b>							
Faroese	5261	Laothian	5861	Sesotho	6566		
Fiji	5256	Latin	5847	Setswana	6660		
Finnish [FIN]	5255	Latvian;Lettish	5868	Shona	6560		
French [FRE]	5264	Lingala	5860	Sindhi	6550		
		Lithuanian	5866	Singhalese	6555		
		Macedonian	5957	Siswat	6565		
		Malagasy	5953	Slovak	6557		
				Slovenian	6558		

If you choose a Language that has a 3-letter language code, the code will be displayed every time you change the Audio or Subtitle Language setting on pages 22-23. If you choose any other languages, '---' will be displayed instead. (3-letter language code is written in bracket.)

MAINTENANCE

Cleaning the Cabinet

- Use a soft cloth slightly moistened with a mild detergent solution. Do not use a solution containing alcohol, spirits, ammonia or abrasives.

Cleaning Discs

- When a disc becomes dirty, clean it with a cleaning cloth. Wipe the disc from the centre out. Do not wipe in a circular motion.
- Do not use solvents such as benzine, thinner, commercially available cleaners, detergent, abrasive cleaning agents or antistatic spray intended for analogue records.

Cleaning the disc lens

- If the player does not perform properly while referring to the relevant sections and to "TROUBLESHOOTING GUIDE" in this User Guide, the laser optical pickup unit may be dirty. Consult your dealer or an Authorized Service Centre for inspection and cleaning of the laser optical pickup unit.

Disc Handling

- Use discs with the following logos on them.
- Handle the discs carefully so that fingerprints and dust do not adhere to the surfaces of the discs.
- Always store the disc in its protective case when it is not used.
- Note that discs with special shapes (heart-shaped discs, octagonal discs, etc.) cannot be played on this player. Do not attempt to play such discs, as they may damage the player.



## TROUBLESHOOTING GUIDE

If the DVD player does not perform properly when operated as instructed in this User Guide, check the player, consulting the following checklist.

<b>Problem</b>	<b>Solution</b>
<b>No power</b>	<ul style="list-style-type: none"> <li>–Check if the AC power cord is properly connected.</li> <li>–Unplug the AC power cord, and wait for 5-10 seconds and then plug it in again.</li> </ul>
<b>No sound or picture</b>	<ul style="list-style-type: none"> <li>–Check if the TV is switched on.</li> <li>–Check the video connection.</li> <li>–Check the VIDEO/AUDIO cable connections to the TV. (Refer to page 14 for Connection to a TV (for video).)</li> <li>–Check if the VIDEO OUT mode is set correctly. See pages 12 and 25.</li> </ul>
<b>Distorted picture</b>	<ul style="list-style-type: none"> <li>–Sometimes a small amount of picture distortion may appear. This is not a malfunction.</li> <li>–Connect the player directly to the TV.</li> <li>–Check if the VIDEO OUT mode is set correctly. See pages 12 and 25.</li> </ul>
<b>Completely distorted picture or black/white picture with DVD</b>	<ul style="list-style-type: none"> <li>–Connect the player directly to the TV.</li> <li>–Make sure the disc is compatible with the player.</li> </ul>
<b>No sound or distorted sound</b>	<ul style="list-style-type: none"> <li>–Adjust the volume.</li> <li>–Check if the speakers are connected correctly.</li> </ul>
<b>No audio at digital output</b>	<ul style="list-style-type: none"> <li>–Check the digital connections.</li> <li>–Check the Audio Setting.</li> </ul>
<b>No DTS audio output</b>	<ul style="list-style-type: none"> <li>–Use DIGITAL OUT jacks when outputting the DTS audio.</li> </ul>
<b>Picture freezes momentarily during playback</b>	<ul style="list-style-type: none"> <li>–Check the disc for fingerprints/scratches and clean with a soft cloth wiping from centre to edge.</li> <li>–Clean the disc.</li> </ul>
<b>Disc can't be played</b>	<ul style="list-style-type: none"> <li>–Clean the disc.</li> <li>–Ensure the disc label is facing up.</li> <li>–Check if the disc is defective by trying another disc.</li> <li>–Cancel the Parental Lock or change the control level.</li> <li>–Insert a correct disc that can be played on this player.</li> </ul>
<b>No return to start-up screen when disc is removed</b>	<ul style="list-style-type: none"> <li>–Reset the player by switching the player off, then on again.</li> </ul>
<b>The player does not respond to the remote control</b>	<ul style="list-style-type: none"> <li>–Aim the remote control directly at the sensor on the front of the player.</li> <li>–Reduce the distance to the player.</li> <li>–Replace the batteries in the remote control.</li> <li>–Re-insert the batteries with their polarities (+/– signs) as indicated.</li> </ul>
<b>Buttons do not work or the player stops responding</b>	<ul style="list-style-type: none"> <li>–To completely reset the player, unplug the AC cord from the AC outlet for 5-10 seconds.</li> </ul>
<b>The remote control doesn't seem to work</b>	<ul style="list-style-type: none"> <li>–Check if the REMOTE CONTROL IN jack on the rear panel is connected.</li> <li>–Check if the REMOTE CONTROL switch is set to the correct position.</li> </ul>
<b>The player does not respond to some operating commands during playback</b>	<ul style="list-style-type: none"> <li>–Operations may not be permitted by the disc. Refer to the instructions of the disc.</li> </ul>
<b>The player cannot read CDs/DVDs</b>	<ul style="list-style-type: none"> <li>–Use a commercially available CD/DVD cleaner to clean the lens before sending the player for repair.</li> </ul>
<b>Angle does not switch</b>	<ul style="list-style-type: none"> <li>–The angle cannot be switched for DVDs which do not contain multiple angles. In some cases multiple angles are only recorded for specific scenes.</li> </ul>
<b>Playback does not start when the title is selected</b>	<ul style="list-style-type: none"> <li>–Check the "PARENTAL" setting.</li> </ul>
<b>The password for rating level has been forgotten</b>	<ul style="list-style-type: none"> <li>–Enter the default password "4737", then your forgotten password will be cleared.</li> </ul>
<b>The player does not recognise DivX® files</b>	<ul style="list-style-type: none"> <li>–Check if the file name, including an extension, consists of more than 136 characters. If that does, the player does not recognise the file.</li> </ul>

### NOTES:

- Some functions are not available in specific modes, but this is not a malfunction. Read the description in this User Guide for details of correct operations.
- Playback from a desired track and Random Playback are not available during Programme Playback.
- Some functions are prohibited on some discs.
- When playing back Video CDs with PBC function, some operations (e.g., select and track repeat) cannot be performed. Cancel PBC function temporarily to perform those operations. See page 15.

## SPECIFICATIONS

### SIGNAL SYSTEM

PAL colour

### APPLICABLE DISCS

- (1) DVD-Video Discs
  - 1-layer 12cm single-sided discs, 2-layer 12cm single-sided discs, 2-layer 12cm double-sided discs (1 layer per side)
  - 1-layer 8cm single-sided discs, 2-layer 8cm single-sided discs, 2-layer 8cm double-sided discs (1 layer per side)
- (2) DVD-R/DVD-RW
- (3) Compact discs (Audio CD, Video CD)
  - 12cm discs, 8cm discs
- (4) CD-R/CD-RW

### S-VIDEO OUTPUT

Y output level: 1Vp-p (75Ω/ohms)  
 C output level: 0.3Vp-p  
 Output connectors: S connectors, 1 set

### VIDEO OUTPUT

Output level: 1Vp-p (75Ω/ohms)  
 Output connector: Pin jacks, 1 set

### COMPONENT OUTPUT

Y output level: 1Vp-p (75Ω/ohms)  
 C<sub>B</sub>/P<sub>B</sub> output level: 0.7Vp-p (75Ω/ohms)  
 C<sub>R</sub>/P<sub>R</sub> output level: 0.7Vp-p (75Ω/ohms)  
 Output connector: Pin jacks, 1 set

### AUDIO/VIDEO

21-pin scart jack

### AUDIO OUTPUT

Output level: 2Vrms  
 2 channel (L, R) output connector: Pin jack, 1 set

### AUDIO OUTPUT PROPERTIES

- (1) Frequency response
  - 1 DVDs (linear PCM) : 4Hz to 22kHz (48 kHz sampling)
  - : 4Hz to 44kHz (96 kHz sampling)
  - 2 CDs : 4Hz to 20kHz
- (2) S/N ratio : 115dB
- (3) Total harmonic distortion : 1kHz CD: 0.0045%
- (4) Dynamic range : DVD: 100dB  
 CD: 98dB

### DIGITAL AUDIO OUTPUT

Optical digital output: Optical jack, 1 set  
 Coaxial digital output: Pin jack, 1 set

### POWER SUPPLY

AC 200-240V, 50Hz

### POWER CONSUMPTION

12 W

### MAXIMUM EXTERNAL DIMENSIONS

440 (width) x 65 (height) x 313 (depth) mm

### MASS

2.4 kg (5.3 lbs)

### REMOTE CONTROL UNIT

RC6600DV  
 Infrared pulse type  
 Supply: DC 3V, 2 R6P/AA batteries

## PIN CONNECTION (A/V EURO CONNECTOR)

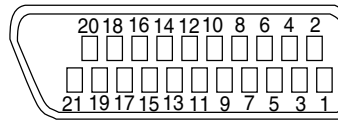

### Contacts, signal levels and impedances

<i>Contact 1</i>		
Audio Output (Right):		2.0Vrms/ 1kΩ
<i>Contact 3</i>		
Audio Output (Left):		2.0Vrms/ 1kΩ
<i>Contact 4</i>		
Audio, Ground		
<i>Contact 5</i>		
RGB, Ground (Blue)		
<i>Contact 7</i>		
RGB Output (Blue):		0.7Vp-p/75Ω
<i>Contact 8</i>		
Function Select Switching Control		
	L :	0.0~2.0V DC Power Off
	M :	4.5~7.0V DC Wide-Screen Mode (16:9)
	H :	9.5~12.0V DC Normal Mode (4:3)
<i>Contact 9</i>		
RGB, Ground (Green)		
<i>Contact 11</i>		
RGB Output (Green):		0.7Vp-p/75Ω
<i>Contact 13</i>		
RGB, Ground (Red)		
<i>Contact 14</i>		
RGB Switching Control, Ground		
<i>Contact 15</i>		
RGB Output (Red):		0.7Vp-p/75Ω
<i>Contact 16</i>		
RGB Switching Control		
H :		3.3V DC RGB Mode
<i>Contact 17</i>		
Video Output Signal, Ground		
<i>Contact 18</i>		
Video Input Signal, Ground		
<i>Contact 19</i>		
Video Output (CVBS):		1.0Vp-p/75Ω
<i>Contact 21</i>		
Common Ground (shielding)		

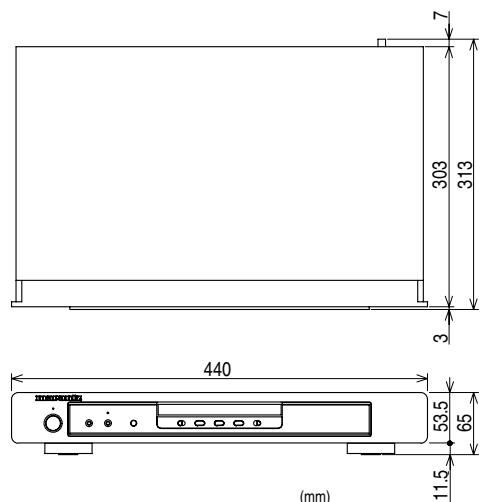

**www.marantz.com**

You can find your nearest authorized distributor or dealer on our website.

---

**U.S.A** Marantz America, Inc.

1100 Maplewood Drive, Itasca, IL 60143, U.S.A.

**EUROPE** Marantz Europe B.V.

P.O. Box 8744, 5605 LS Eindhoven, The Netherlands

---

**marantz**<sup>®</sup> is a registered trademark.



2005/10

00M38BW851320 R

Printed in China

1VMN21446  
E61MA/MBED ★★★★★